

EXPLODED DRAWING A

Model No. 831.23946.3 R1013A

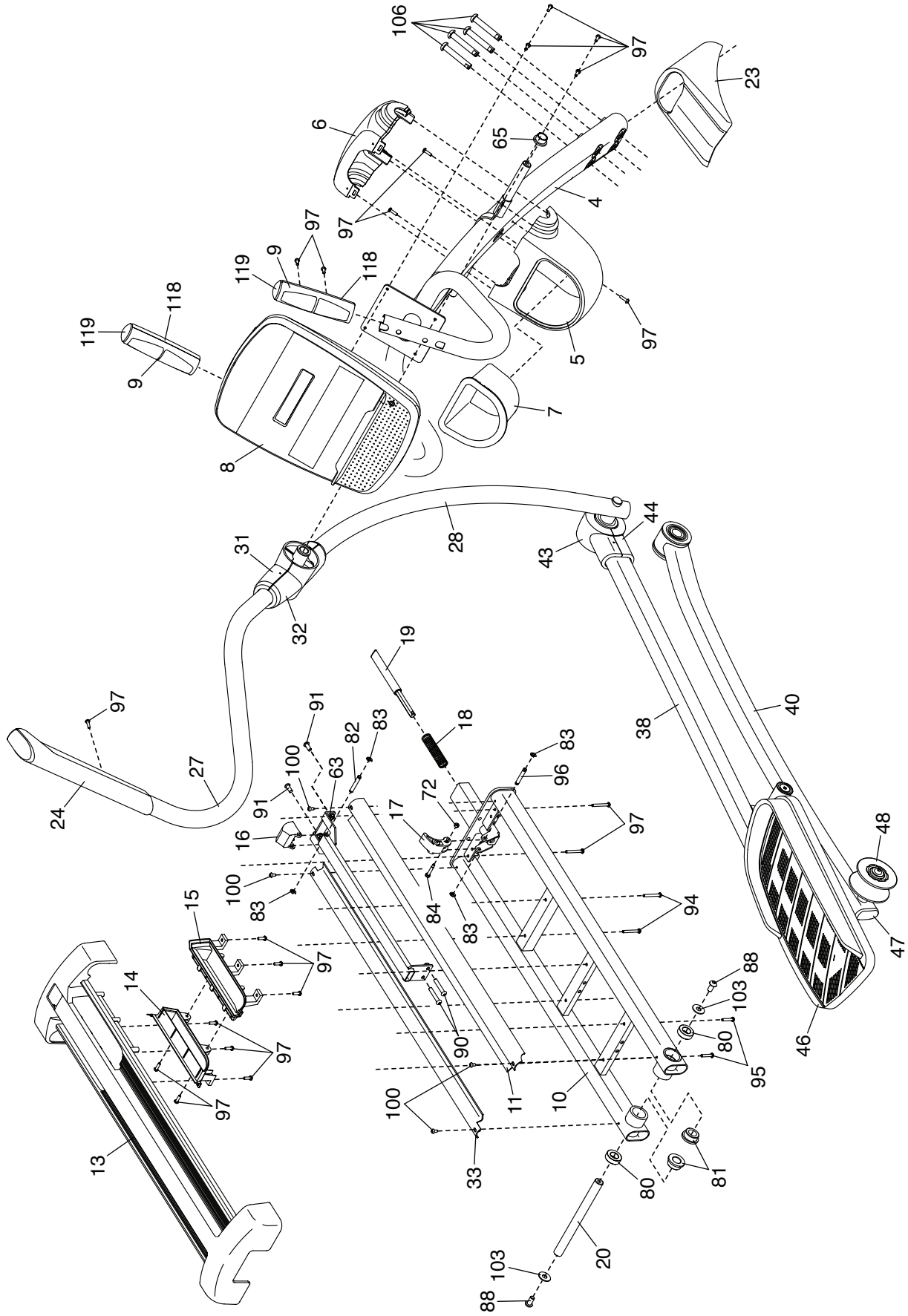

EXPLODED DRAWING B

Model No. 831.23946.3 R1013A

