

EXPLODED DRAWING A

Model No. 831.23946.6 R0814A

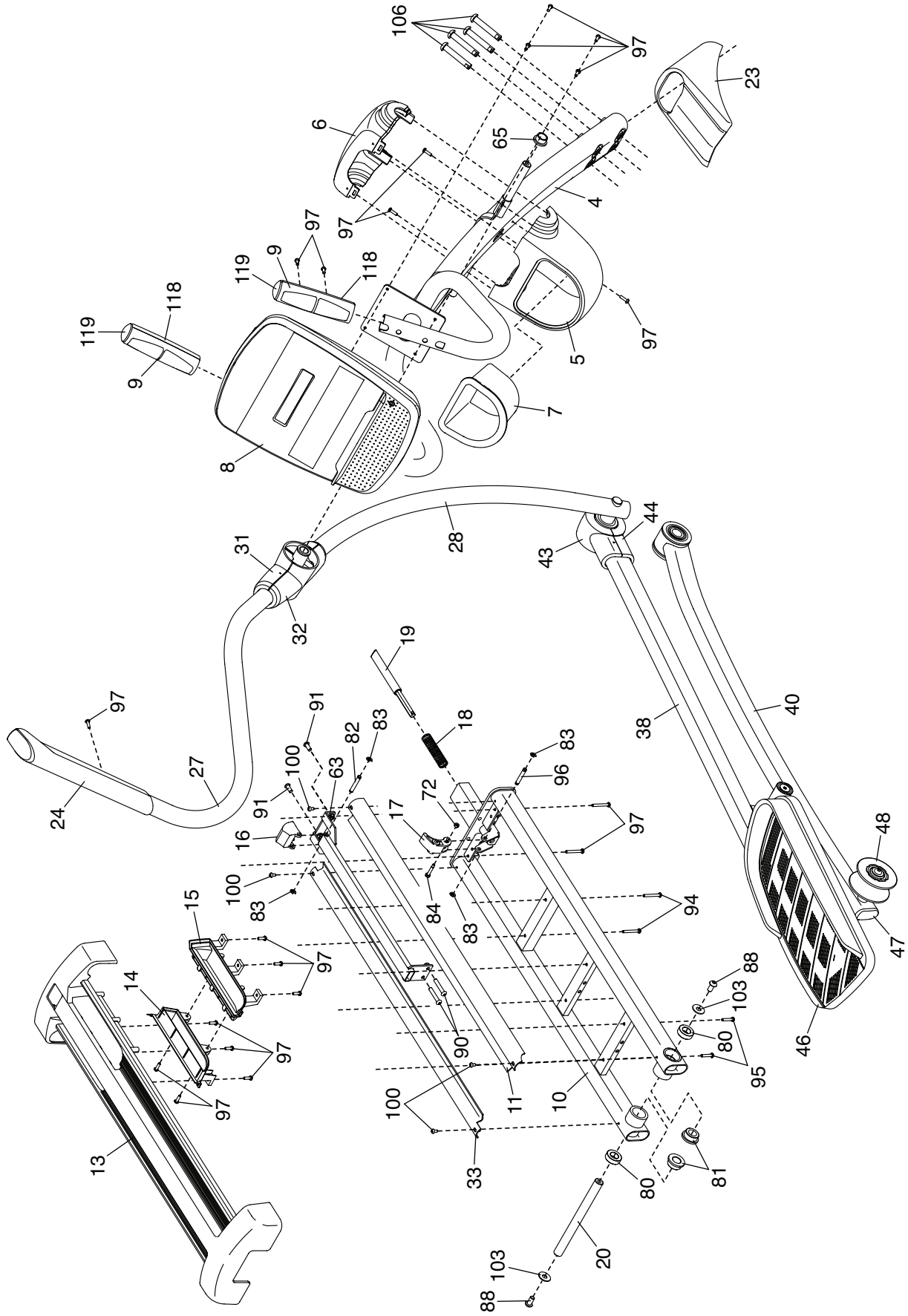

EXPLODED DRAWING B

Model No. 831.23946.6 R0814A

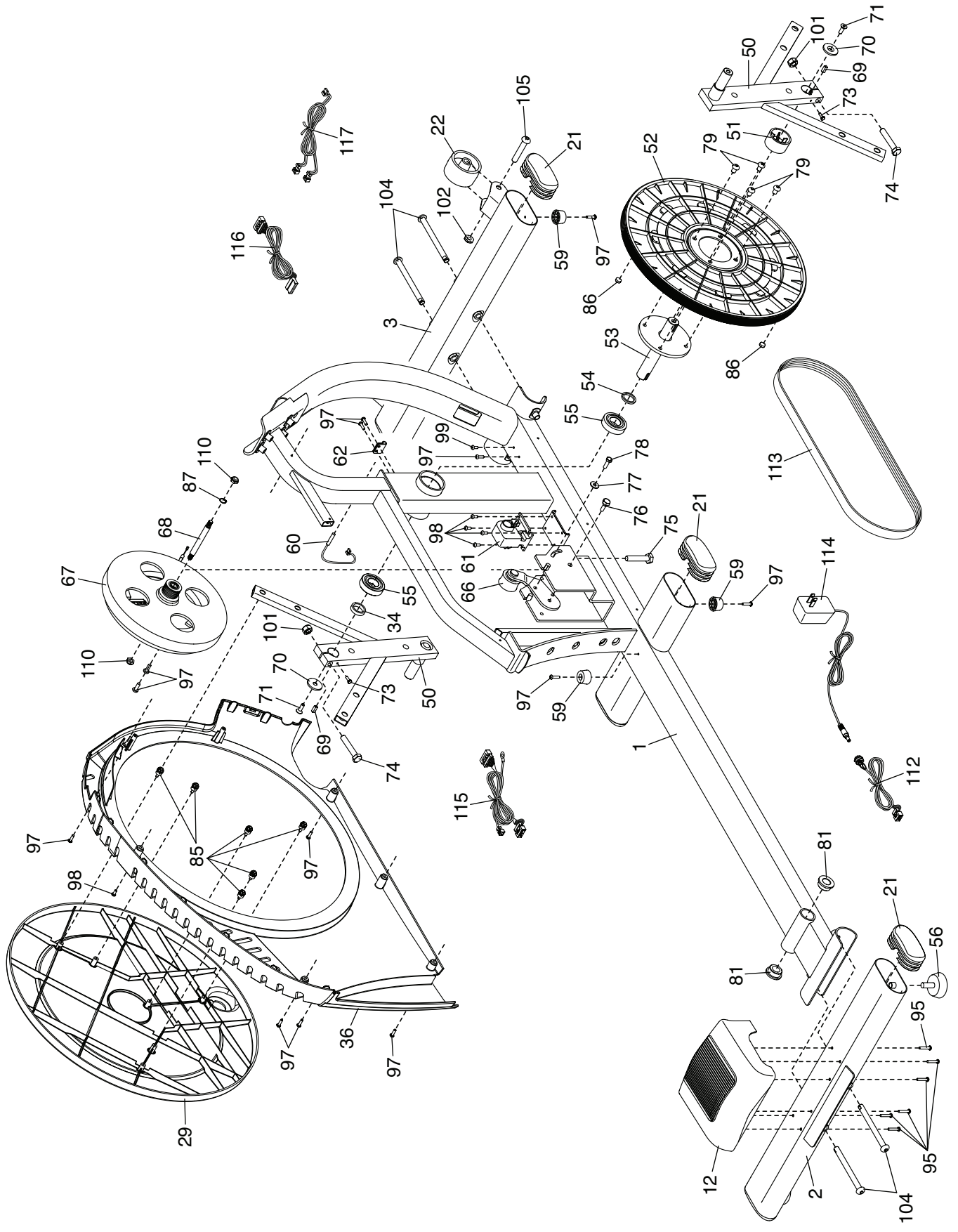

EXPLODED DRAWING C

Model No. 831.23946.6 R0814A

