

EXPLODED DRAWING A

Model No. 831.23952.0 R1014A

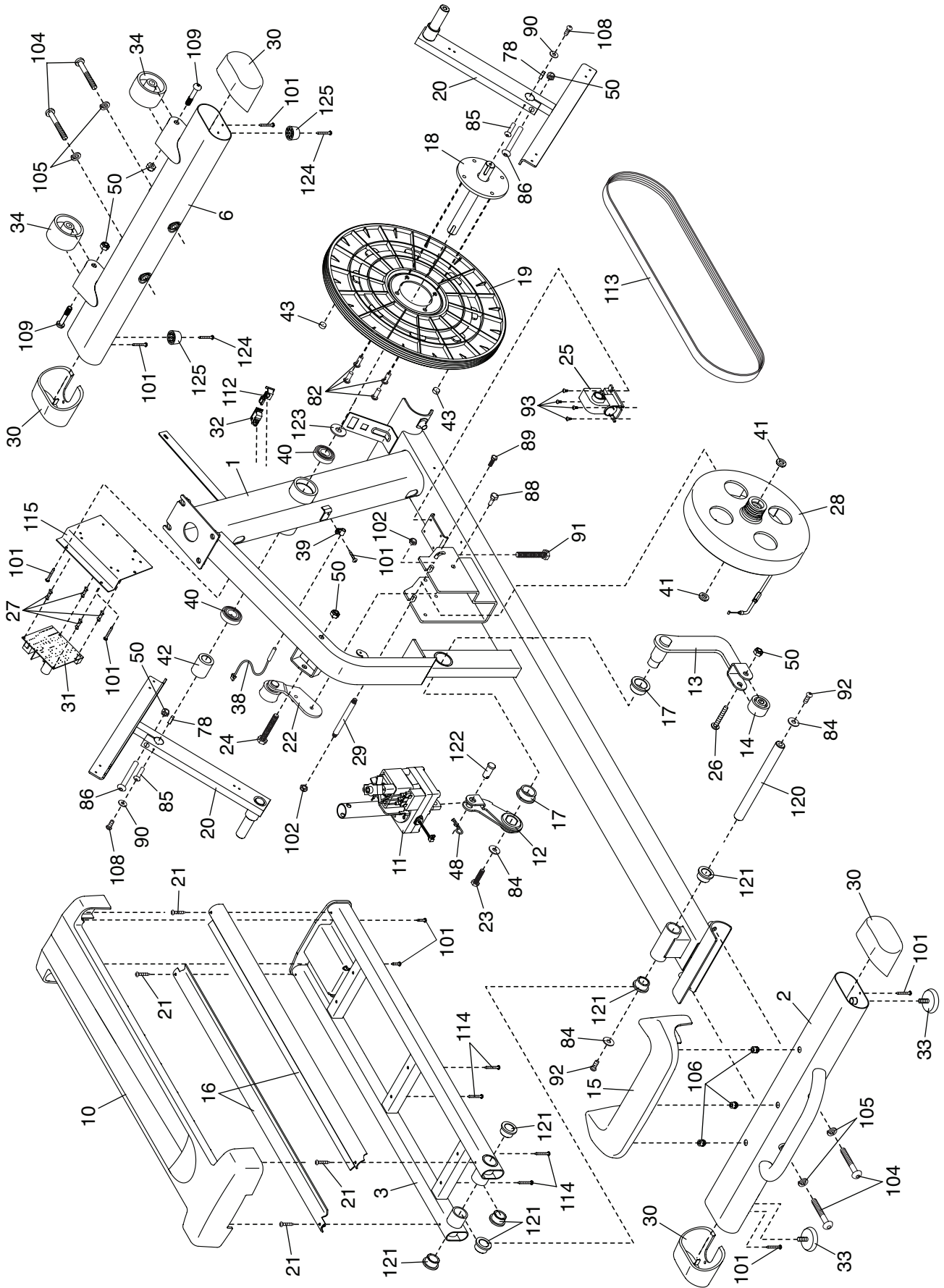

EXPLODED DRAWING B

Model No. 831.23952.0 R1014A

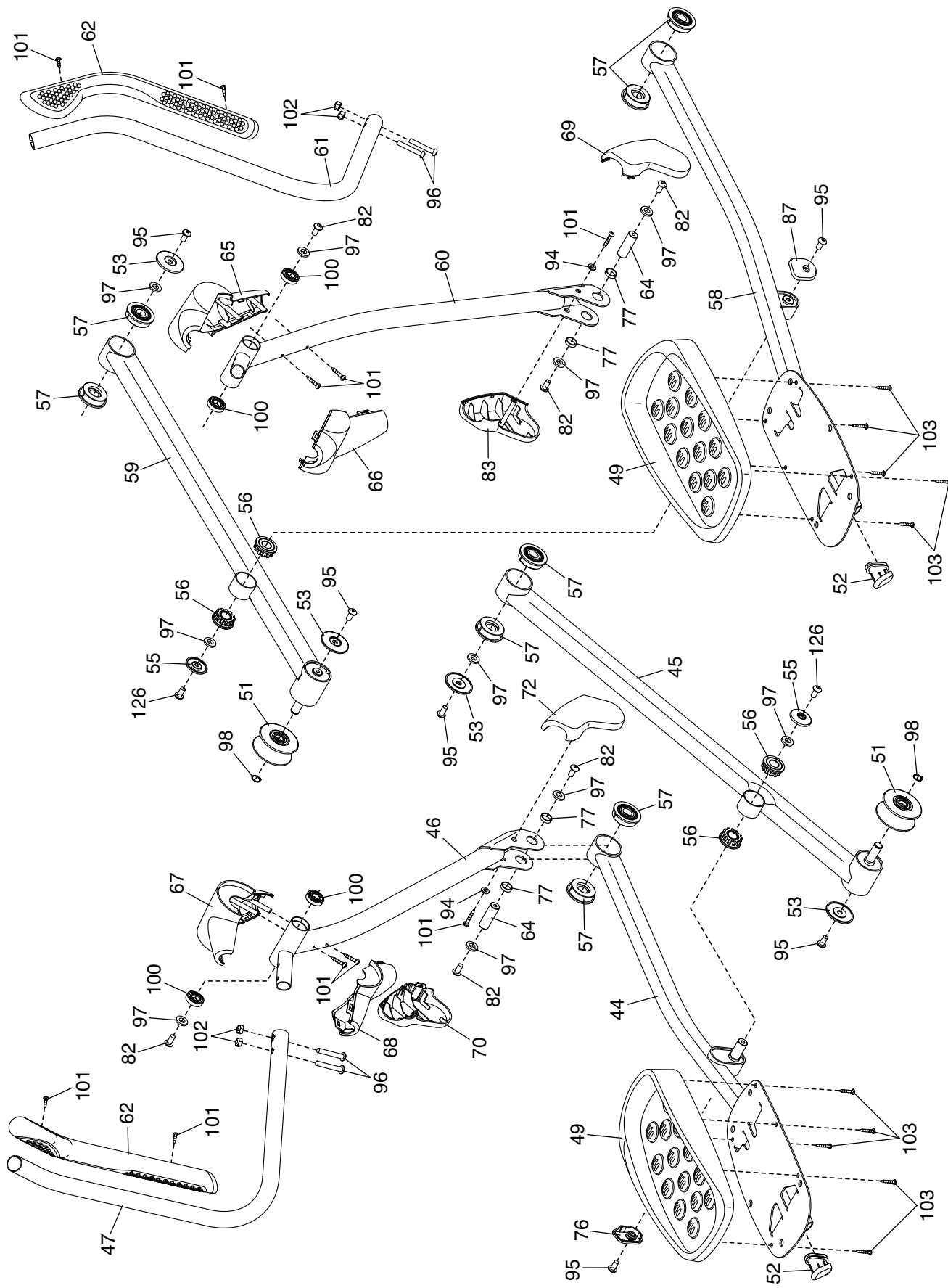

EXPLODED DRAWING C

Model No. 831.23952.0 R1014A

