

EXPLODED DRAWING A

Model No. 831.23953.1 R0112A

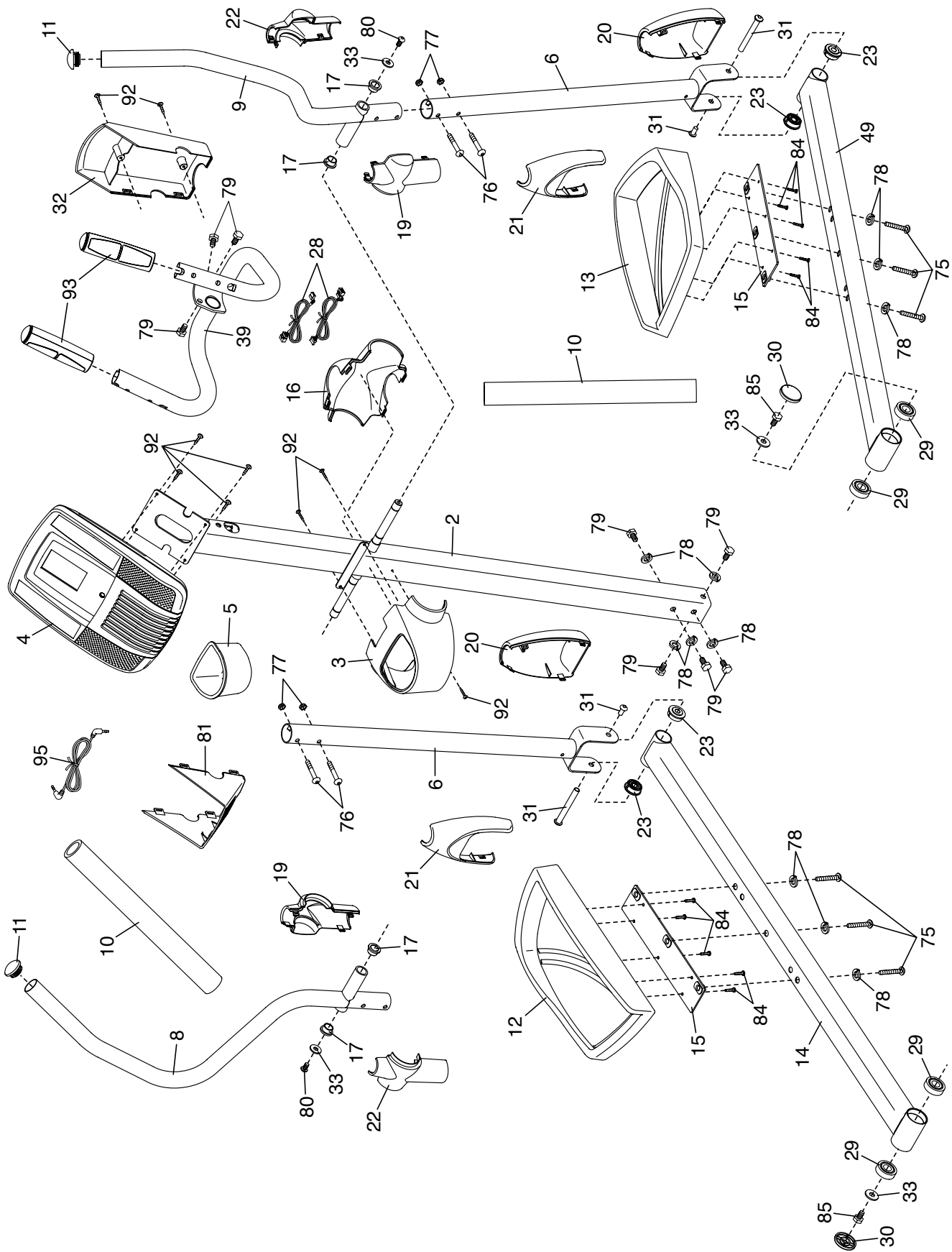

EXPLODED DRAWING B

Model No. 831.23953.1 R0112A

