

# EXPLODED DRAWING A

Model No. 831.23954.0 R1213A

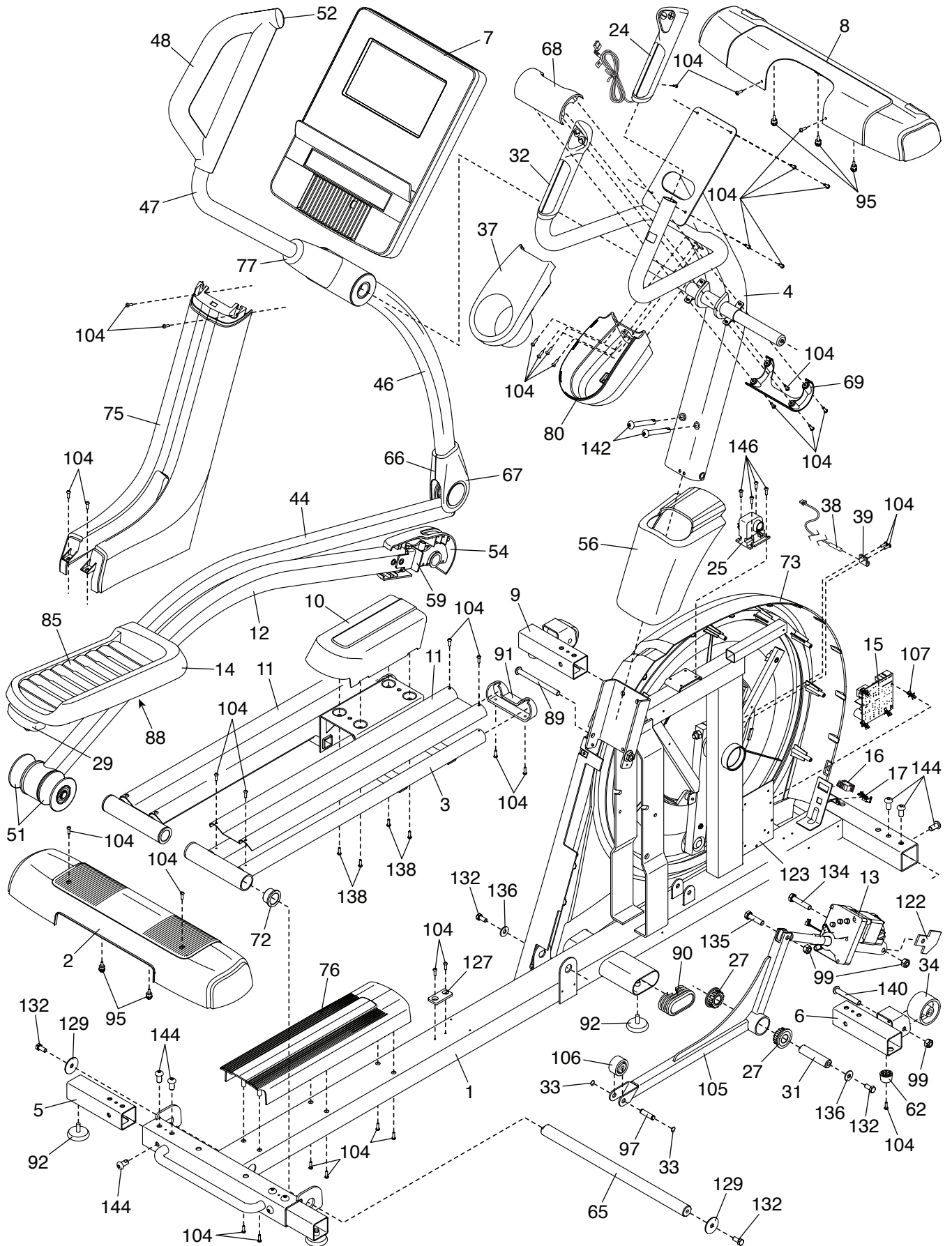

# EXPLODED DRAWING B

Model No. 831.23954.0 R1213A

