

EXPLODED DRAWING A

Model No. 831.23954.2 R0415B

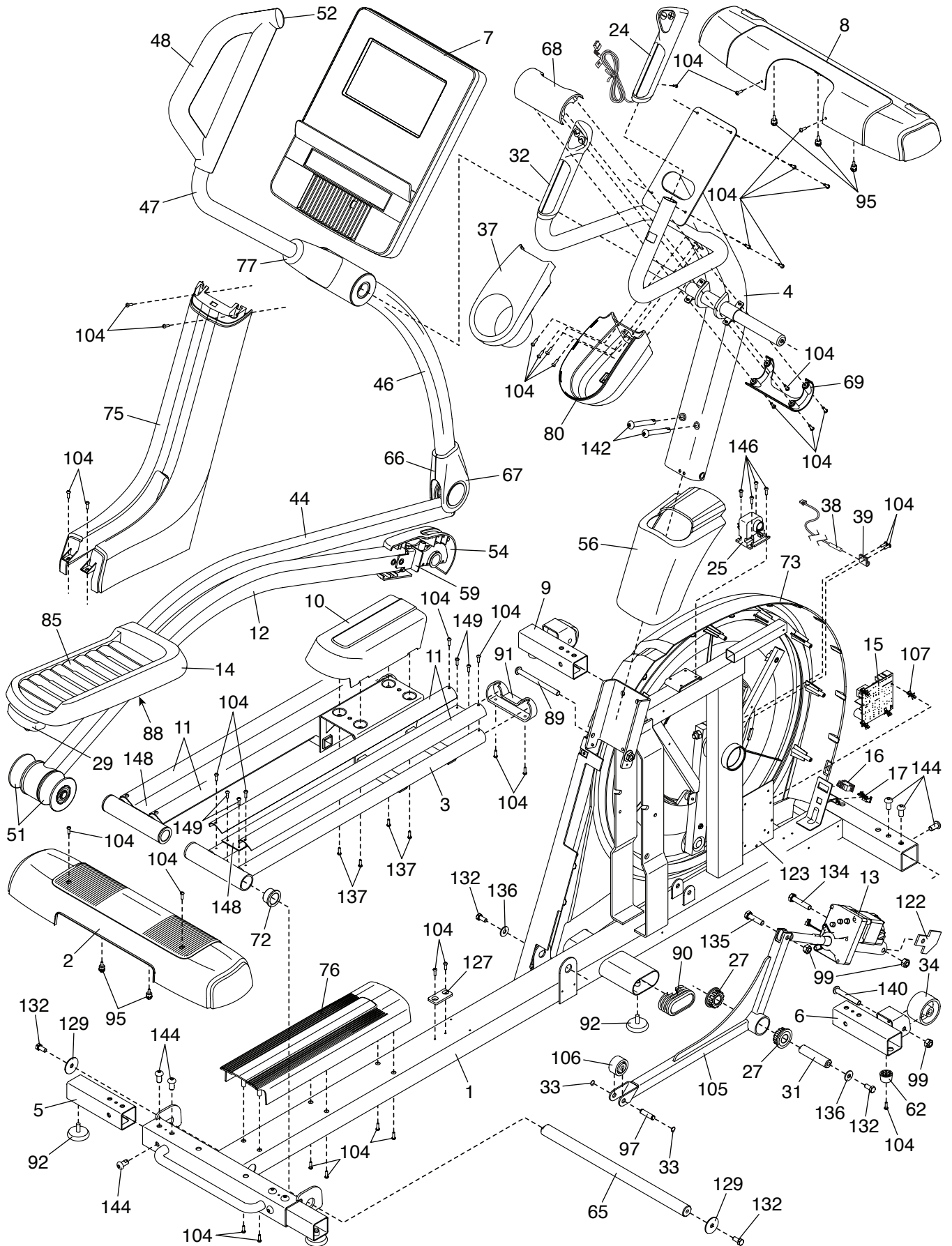

EXPLODED DRAWING B

Model No. 831.23954.2 R0415B

