

# EXPLODED DRAWING A

Model No. NTEL06011.0 R0112A

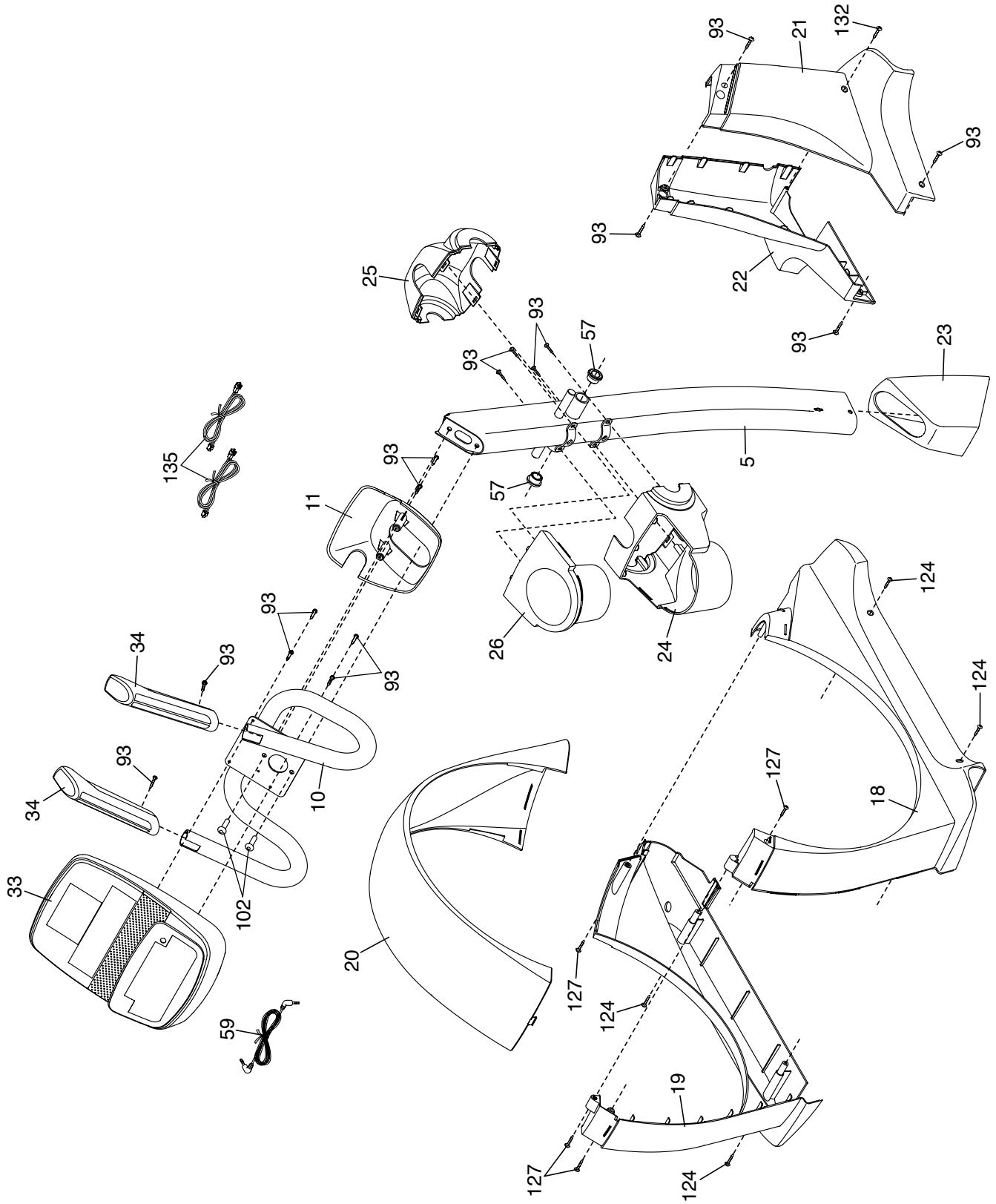

# EXPLODED DRAWING B

Model No. NTEL06011.0 R0112A

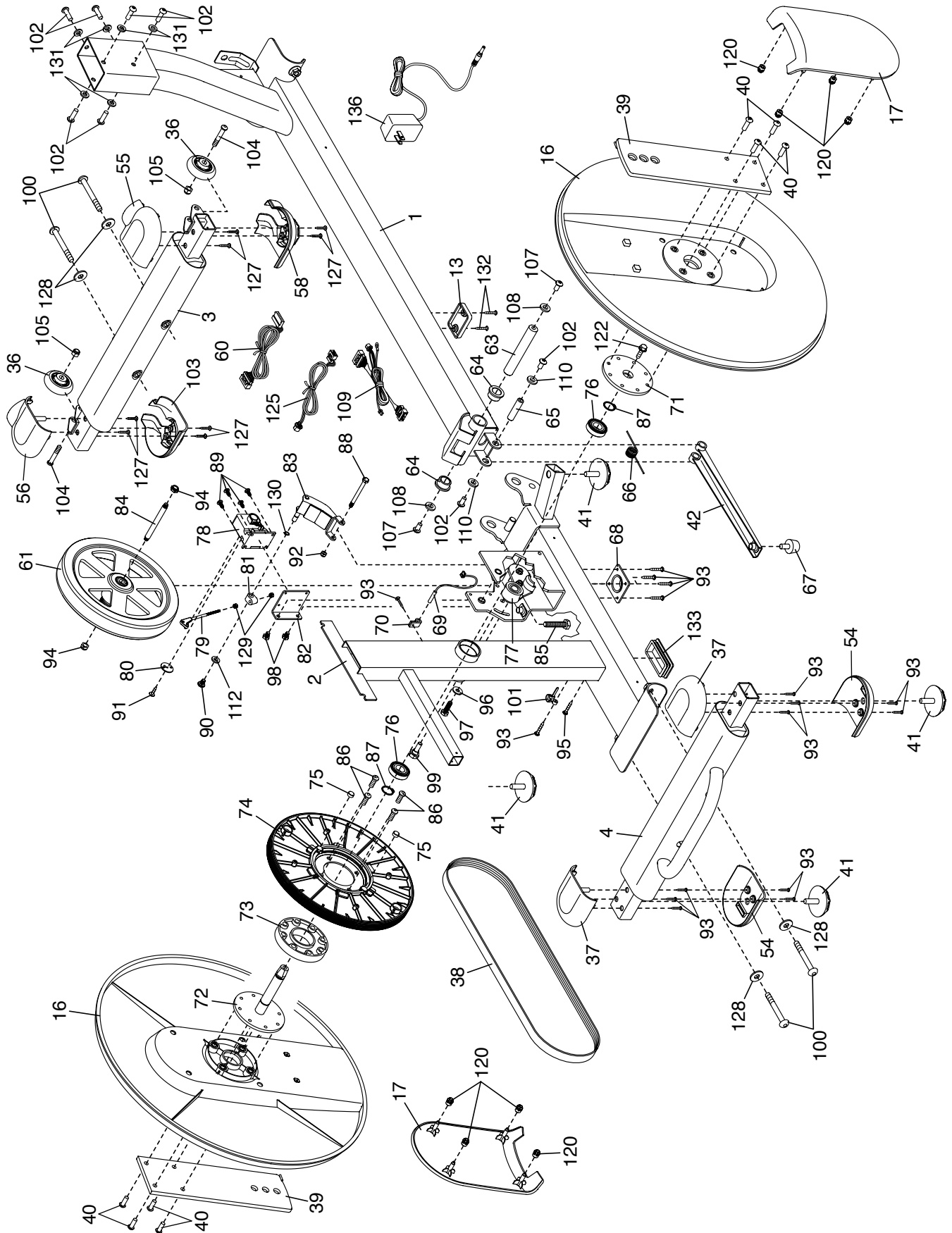

# EXPLODED DRAWING C

Model No. NTEL06011.0 R0112A

