

EXPLODED DRAWING A

Model No. 831.23957.0 R0314A

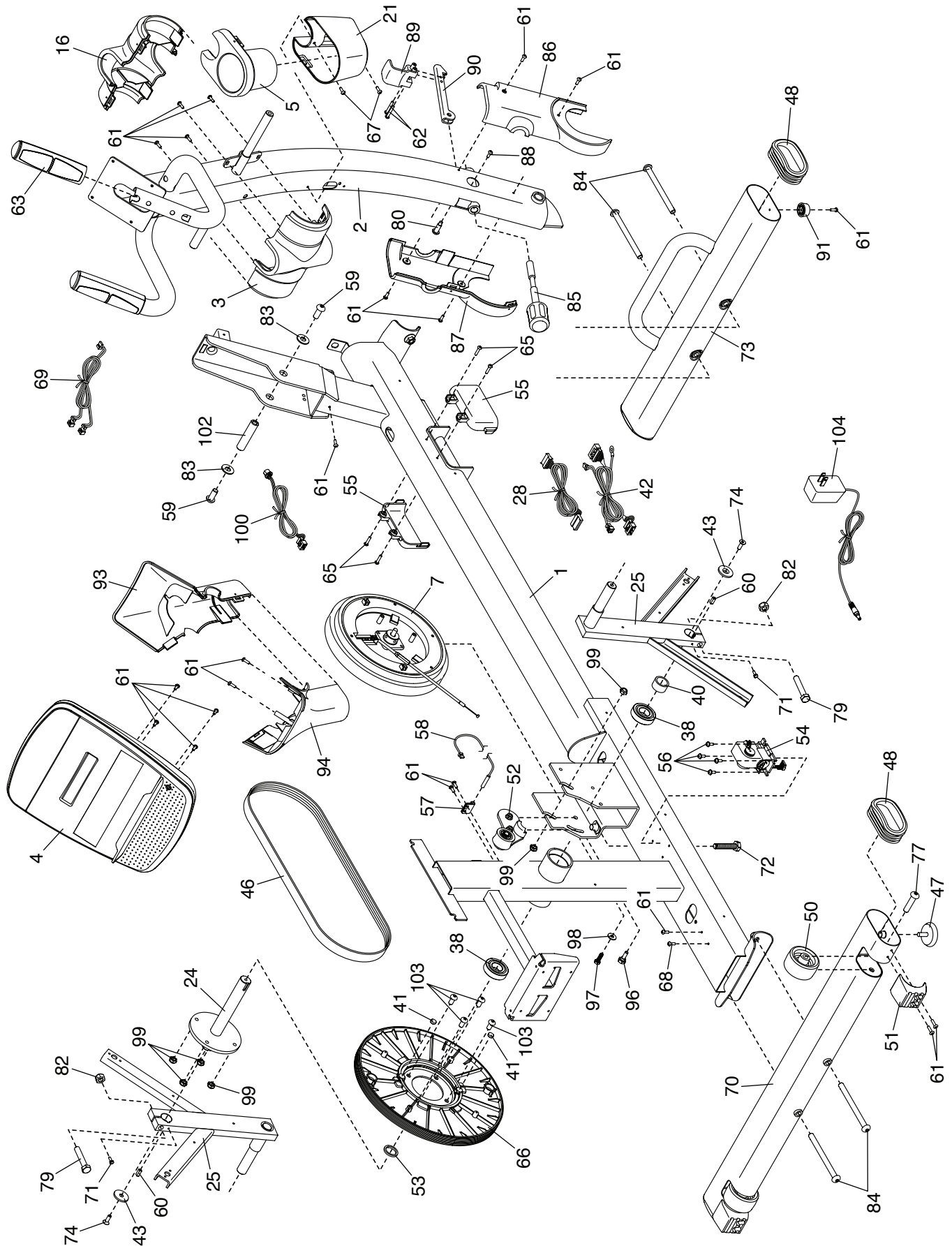

EXPLODED DRAWING B

Model No. 831.23957.0 R0314A

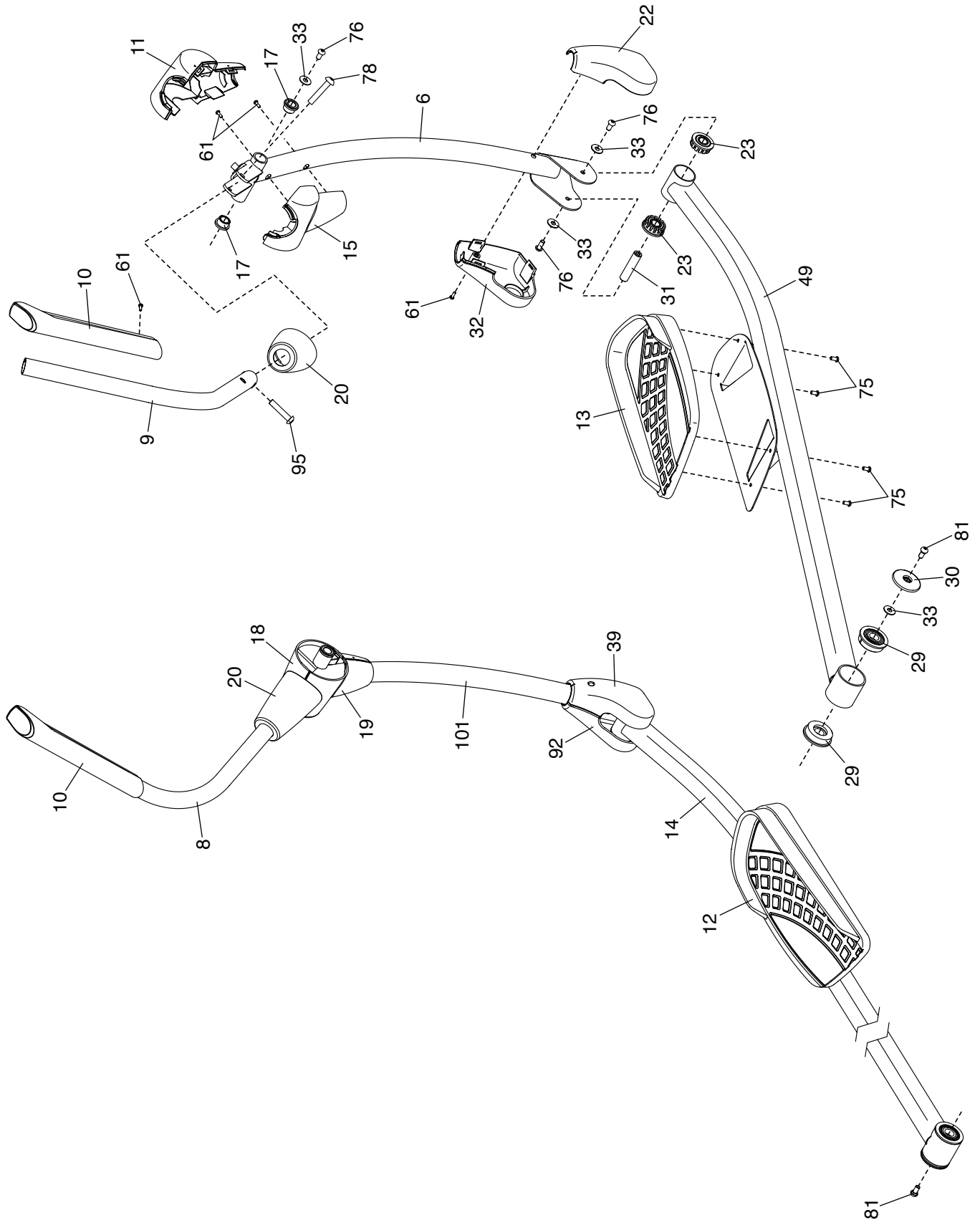

EXPLODED DRAWING C

Model No. 831.23957.0 R0314A

