

# EXPLODED DRAWING A

Model No. 831.23957.2 R0314A

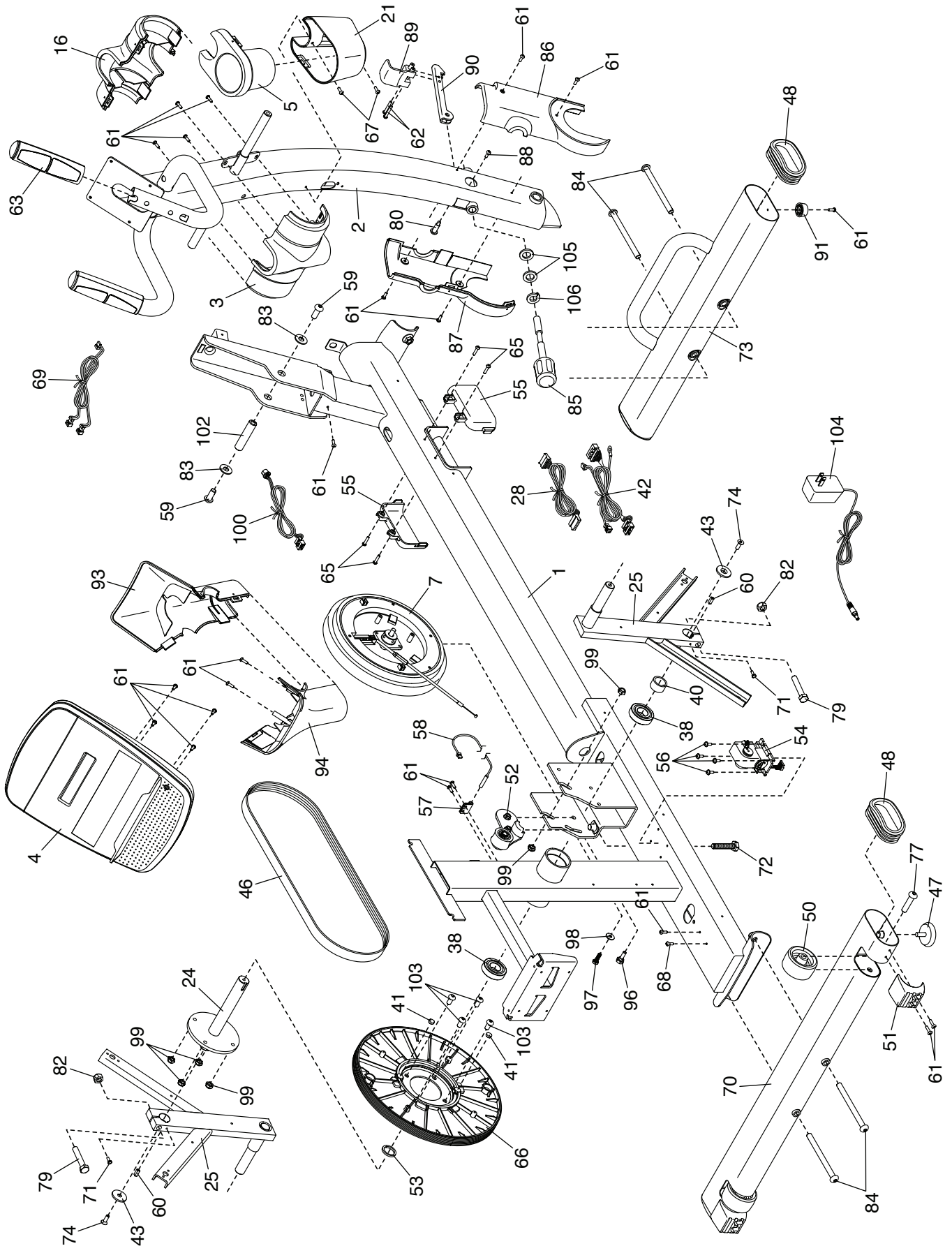

# EXPLODED DRAWING B

Model No. 831.23957.2 R0314A

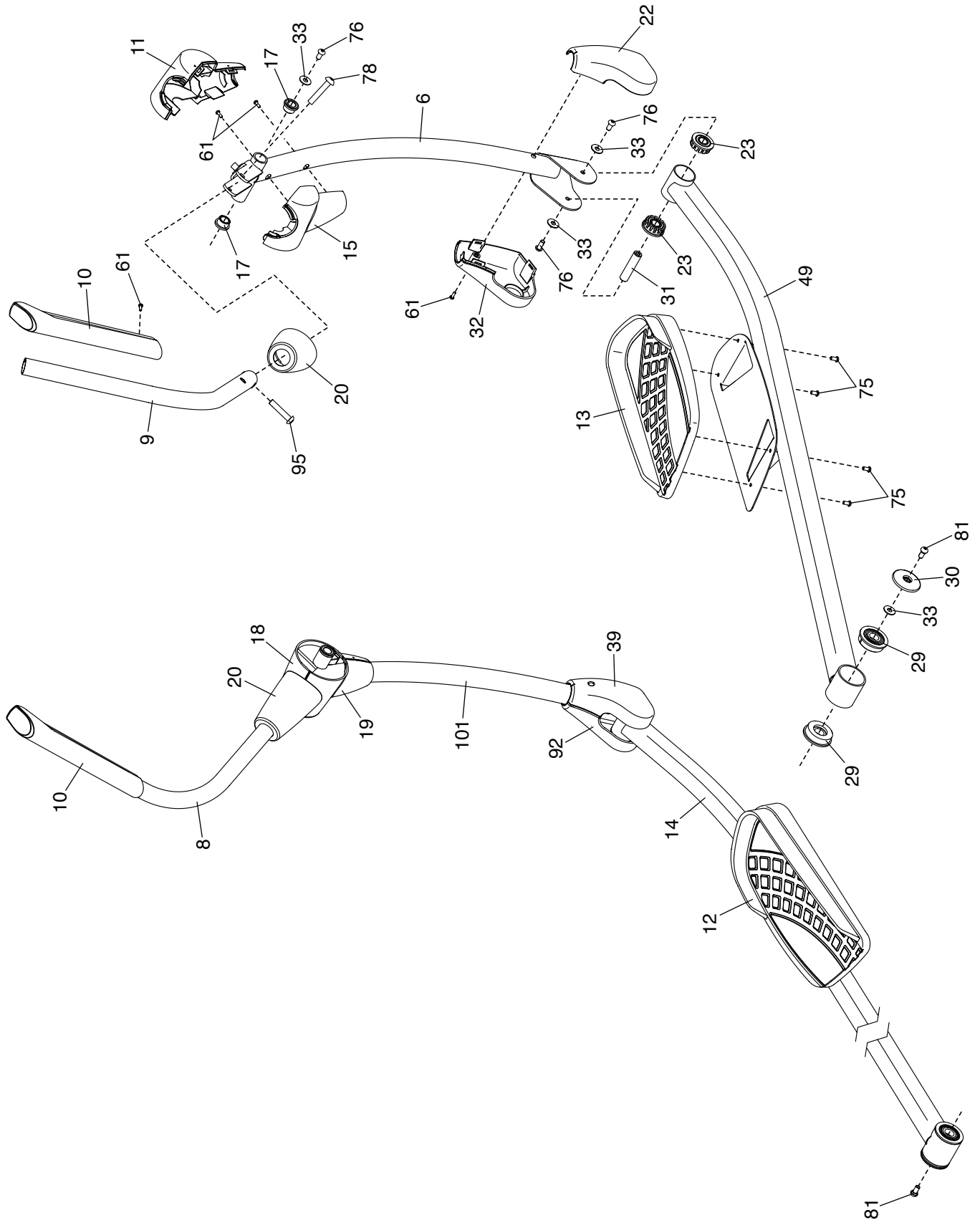

# EXPLODED DRAWING C

Model No. 831.23957.2 R0314A

