

EXPLODED DRAWING A

Model No. 24032.1 R0916A

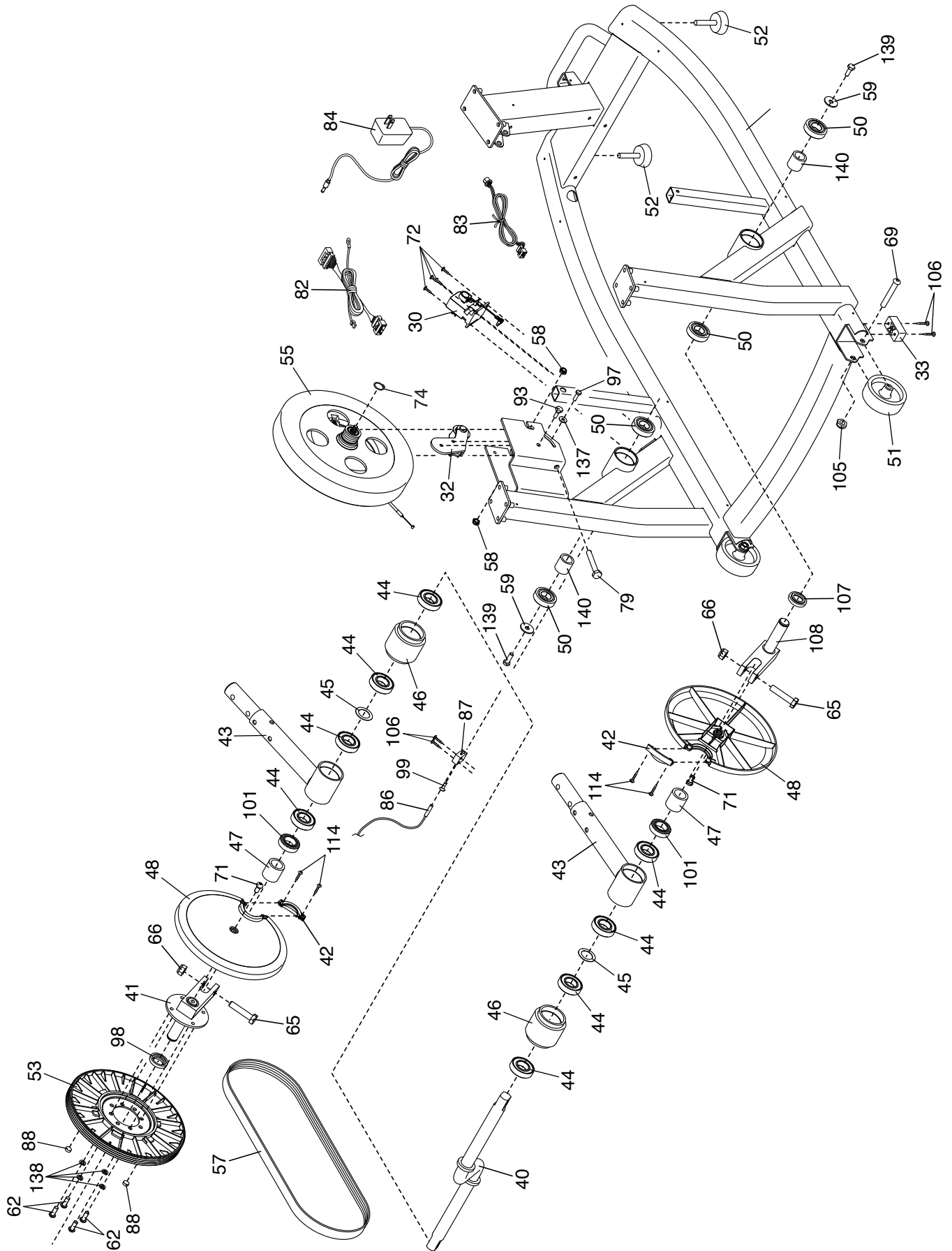

EXPLODED DRAWING B

Model No. 24032.1 R0916A

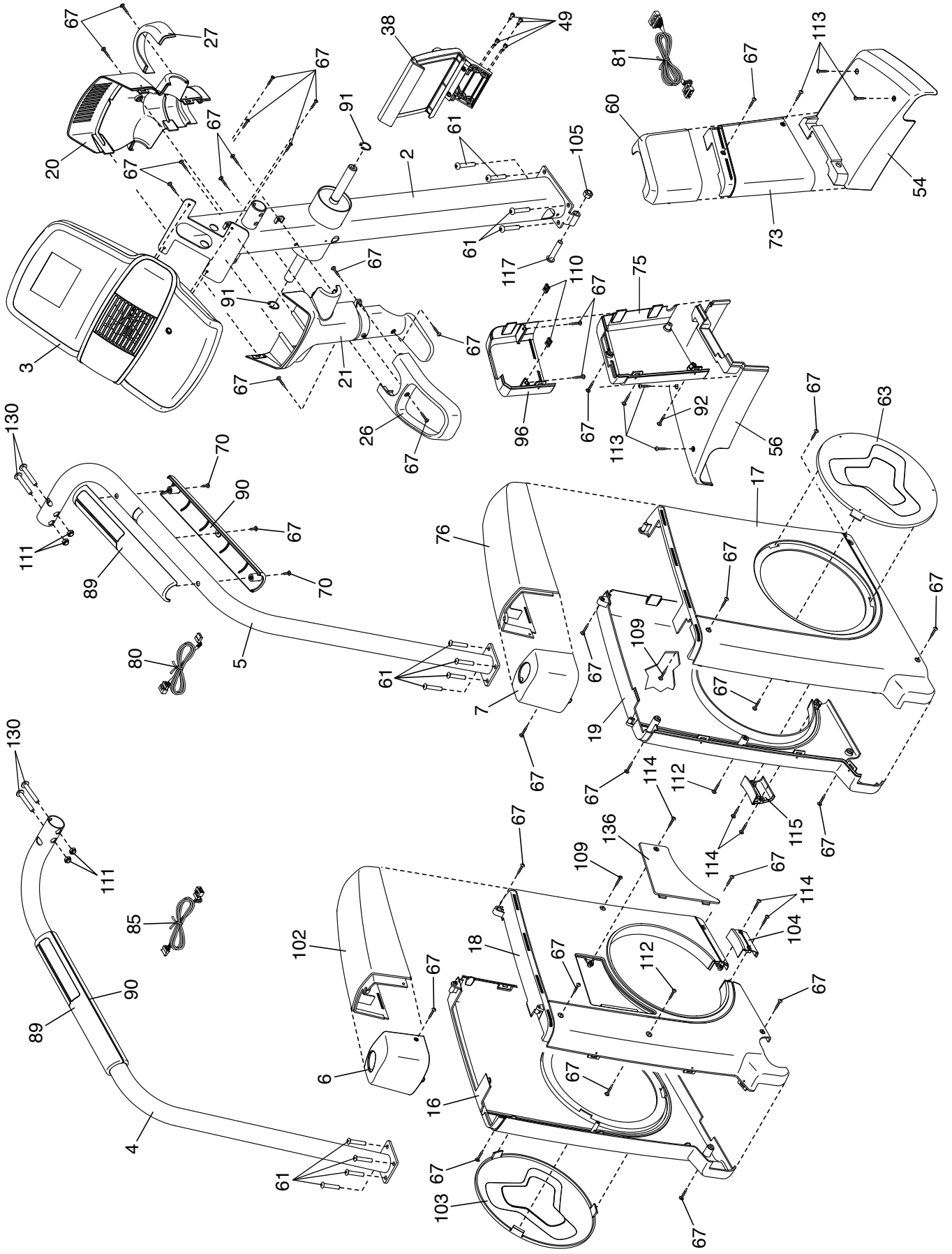

EXPLODED DRAWING C

Model No. 24032.1 R0916A

