

# EXPLODED DRAWING A

Model No. 24035.0 R0716A

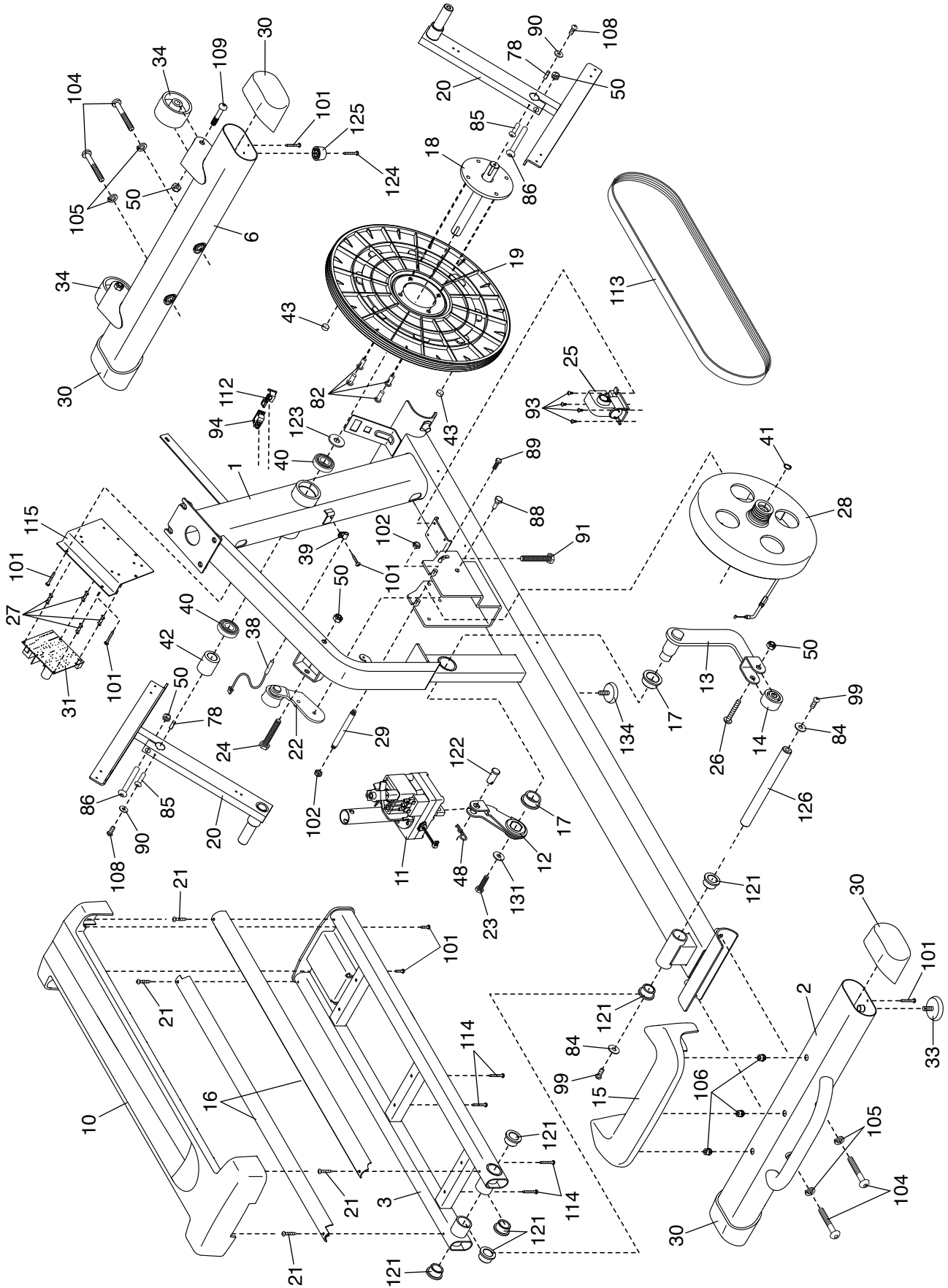

# EXPLODED DRAWING B

Model No. 24035.0 R0716A

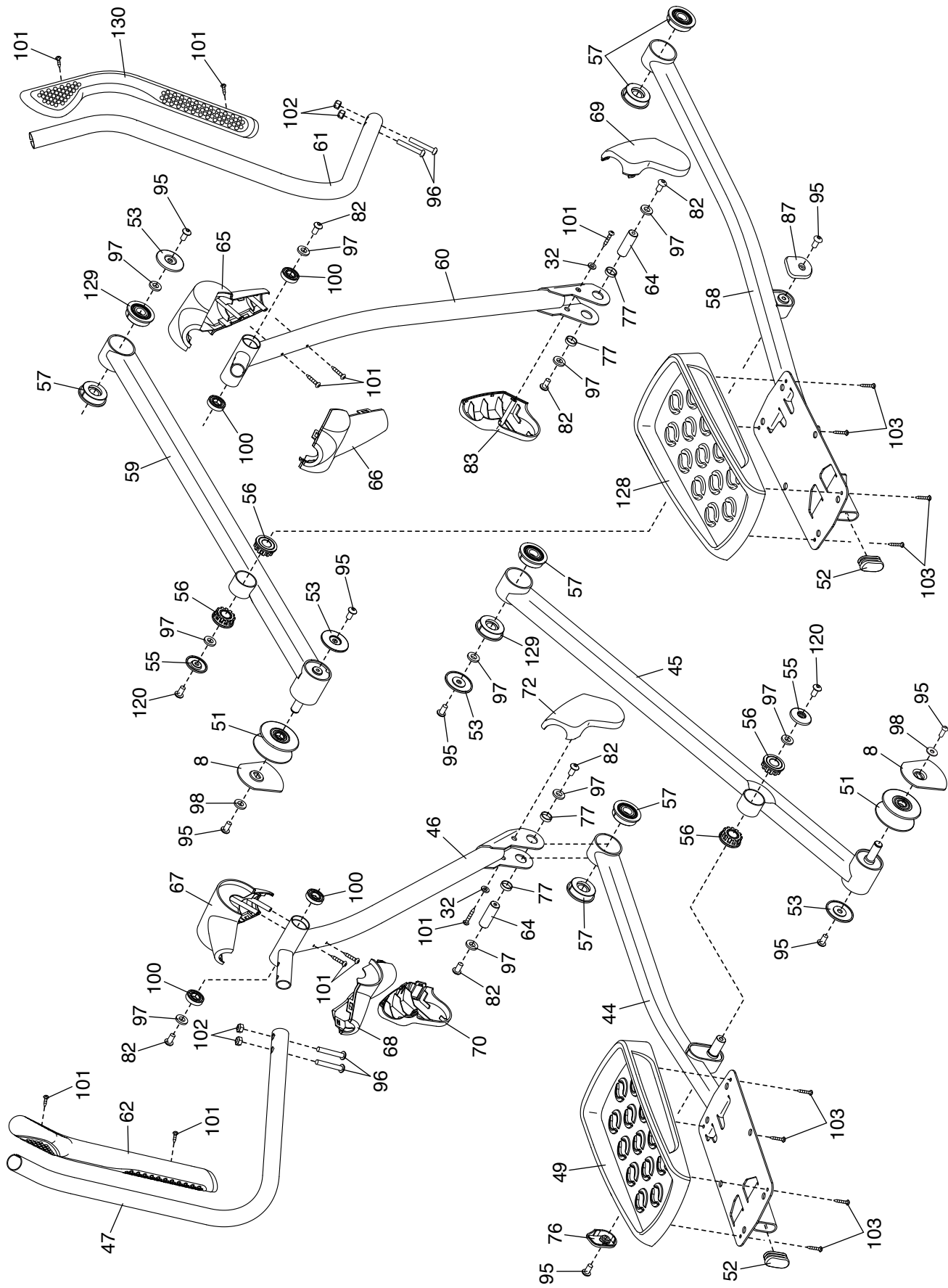

# EXPLODED DRAWING C

Model No. 24035.0 R0716A

