

EXPLODED DRAWING A

Model No. 24035.1 R0716A

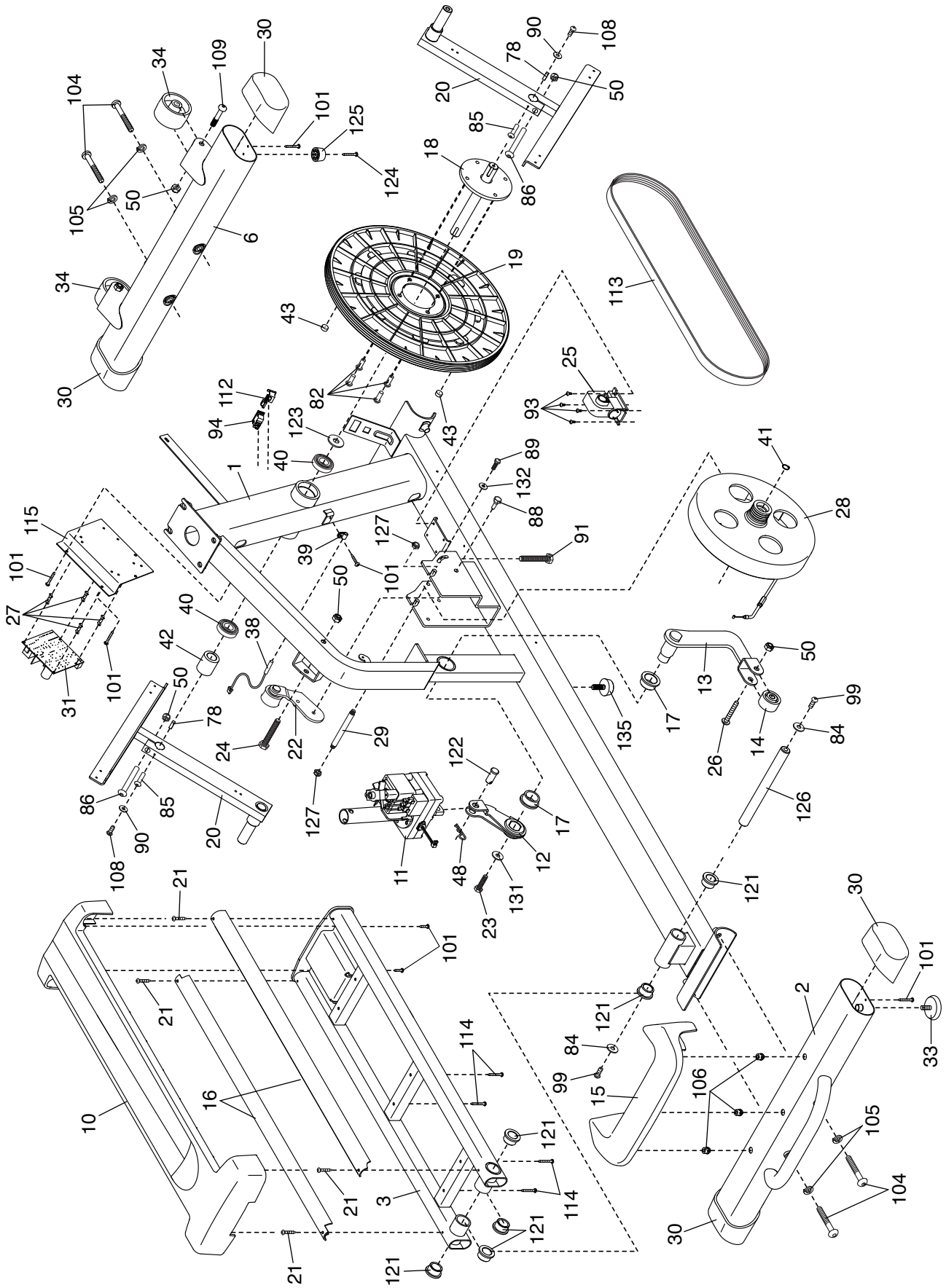

EXPLODED DRAWING B

Model No. 24035.1 R0716A

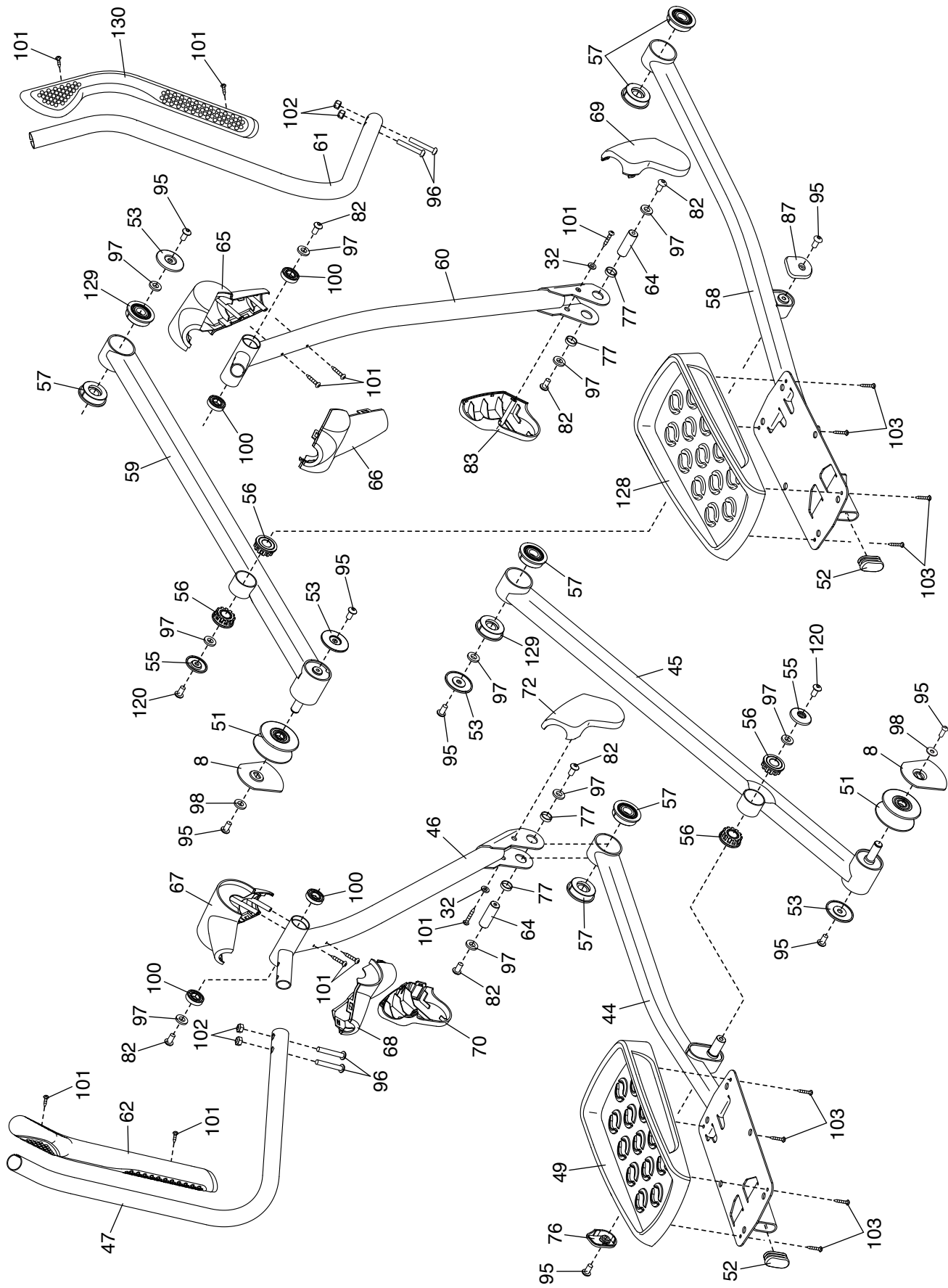

EXPLODED DRAWING C

Model No. 24035.1 R0716A

