

EXPLODED DRAWING A

Model No. 24035.4 R0118A

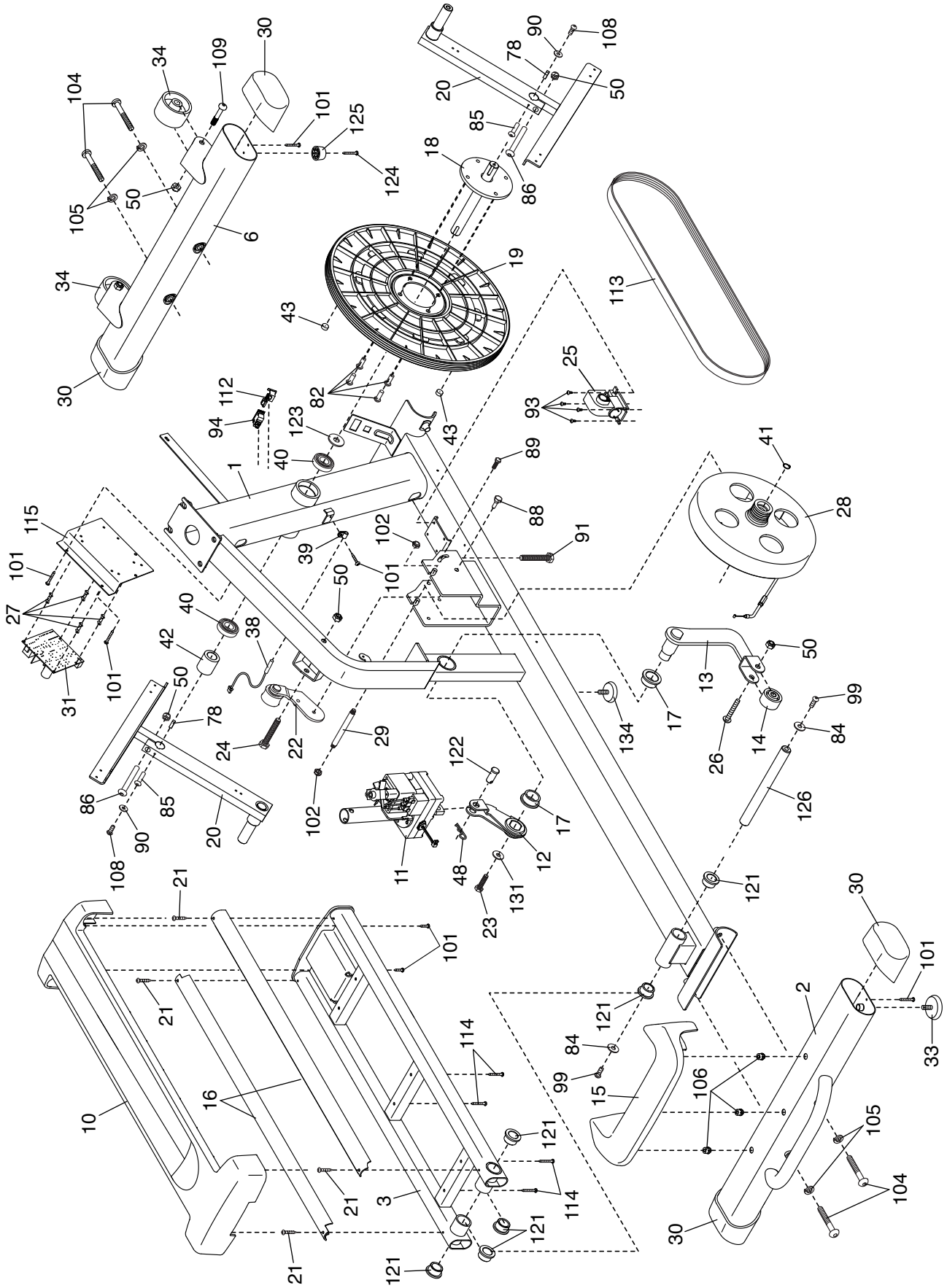

EXPLODED DRAWING C

Model No. 24035.4 R0118A

