

# EXPLODED DRAWING A—Model No. NTL11806.0

R1206A

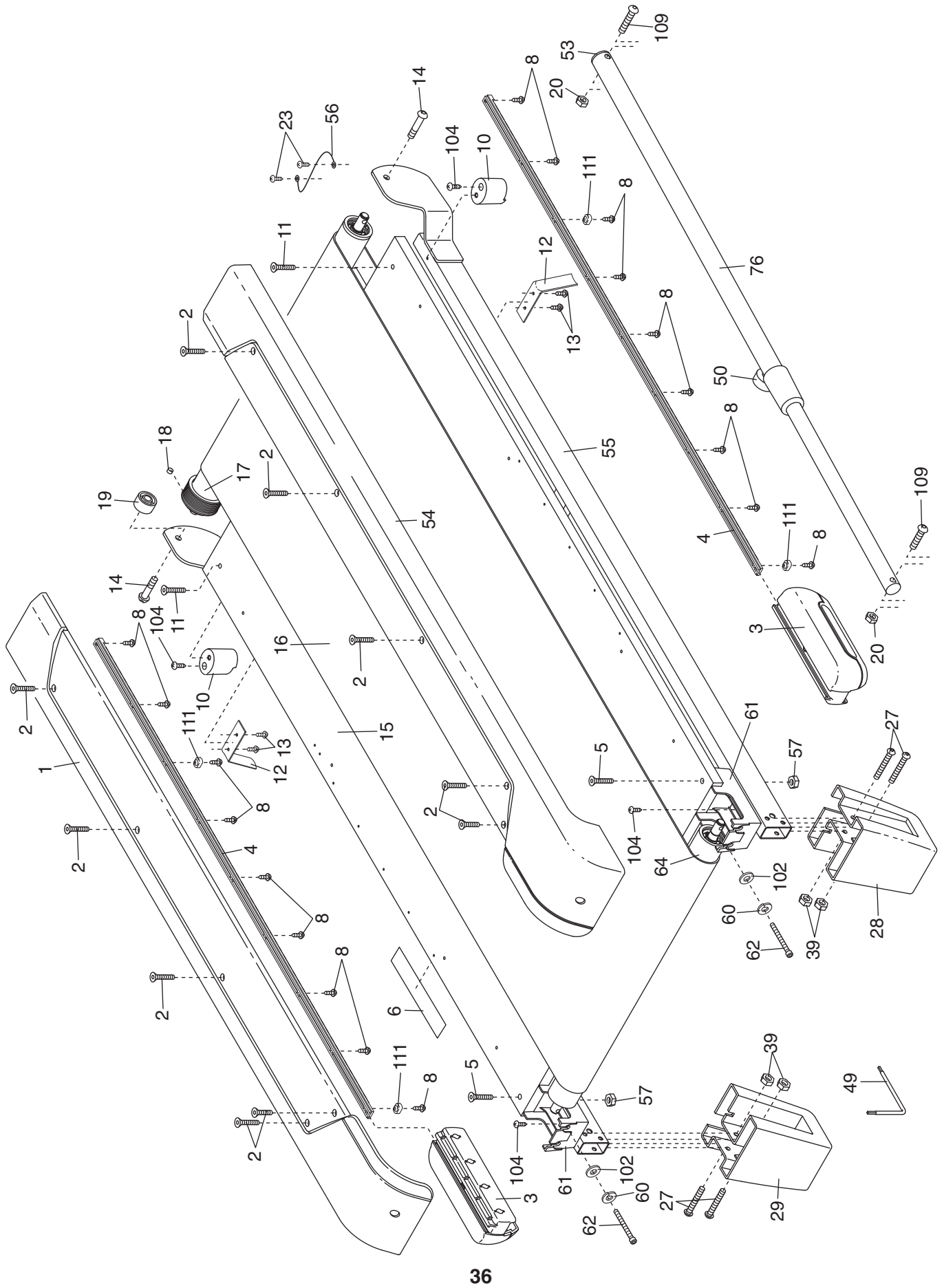

# EXPLODED DRAWING B—Model No. NTL11806.0

R1206A

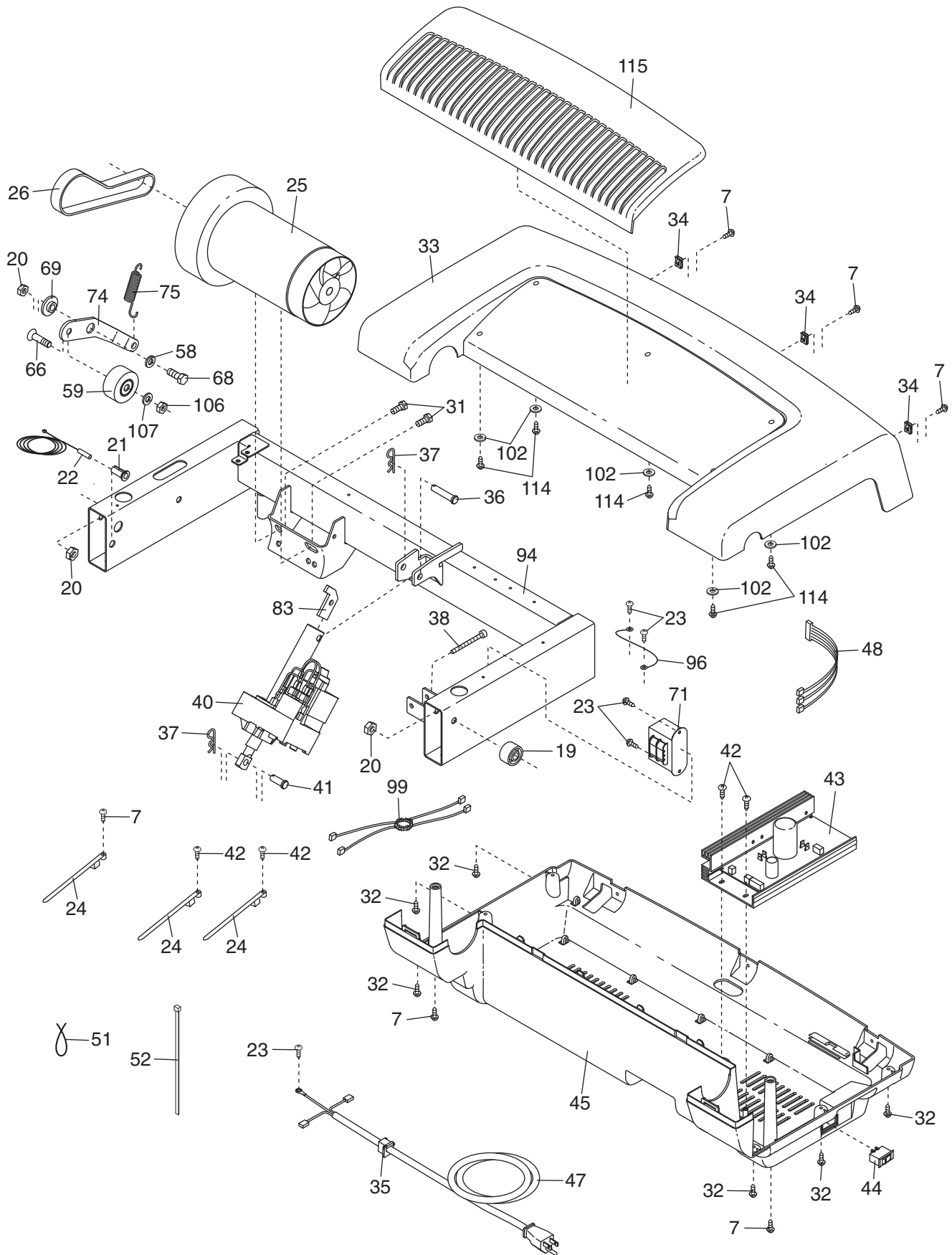

# EXPLODED DRAWING C—Model No. NTL11806.0

R1206A

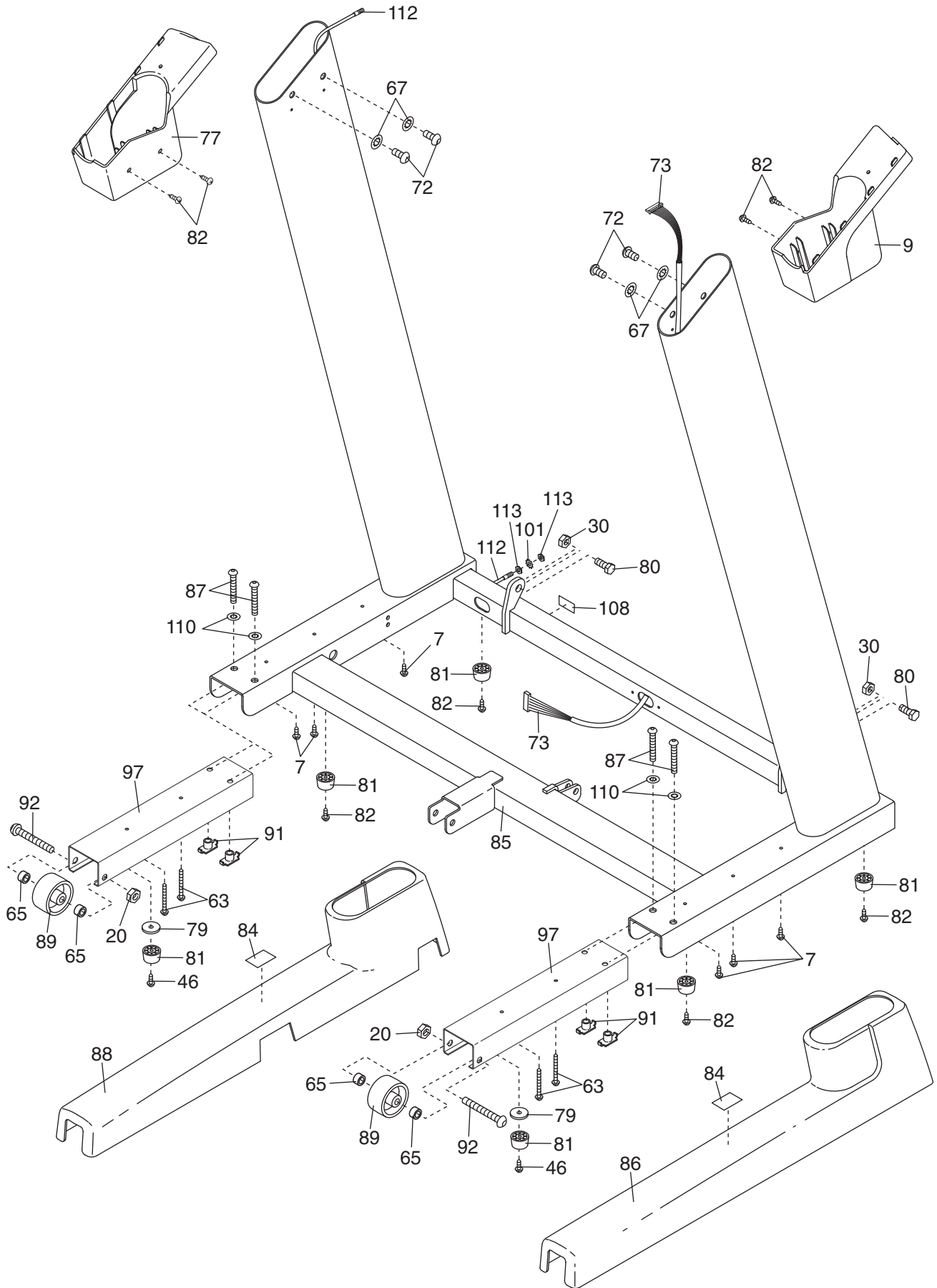

# EXPLODED DRAWING D—Model No. NTL11806.0

R1206A

