

EXPLODED DRAWING A—Model No. 831.24633.0

R0307A

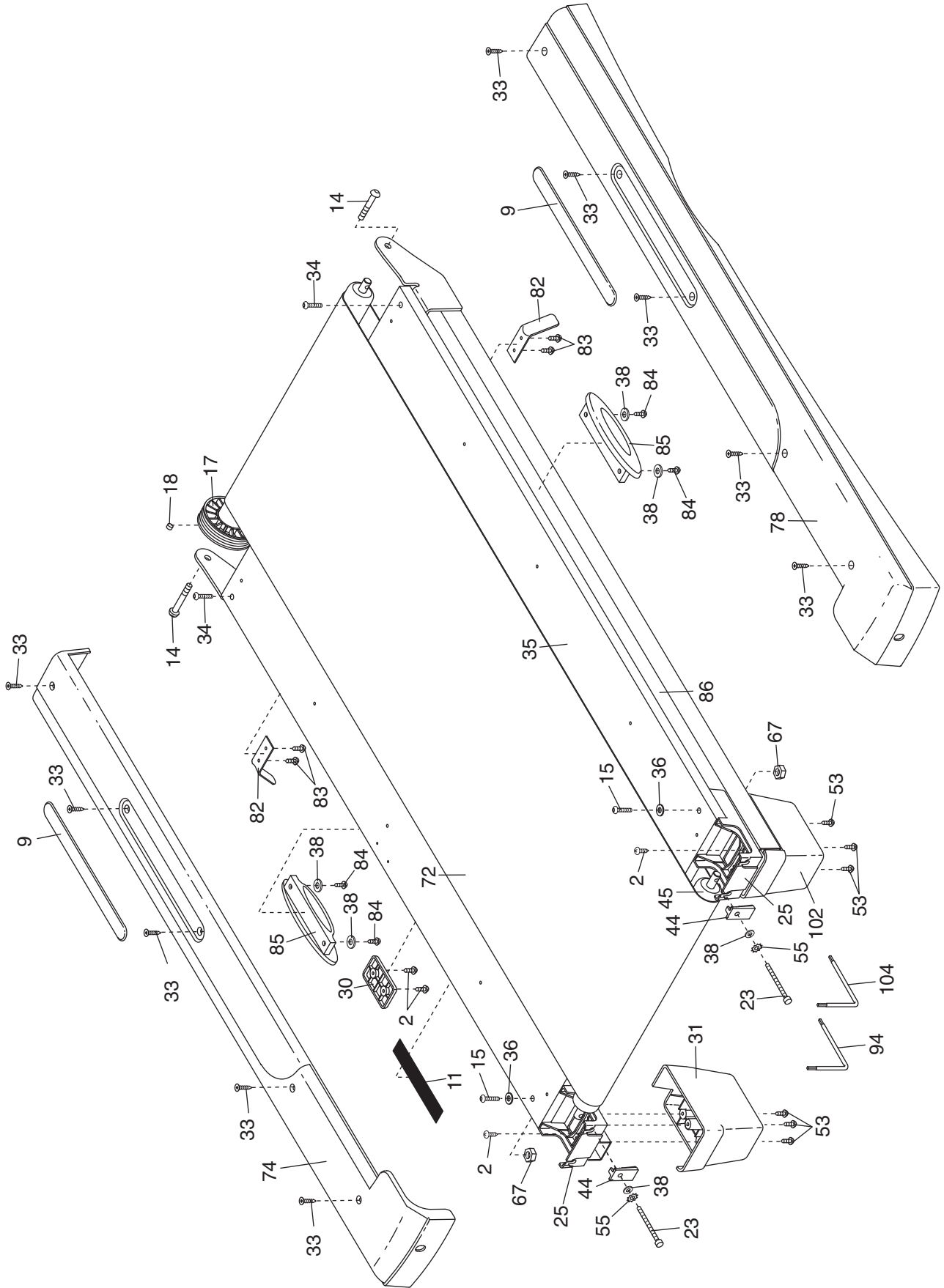

EXPLODED DRAWING B—Model No. 831.24633.0

R0307A

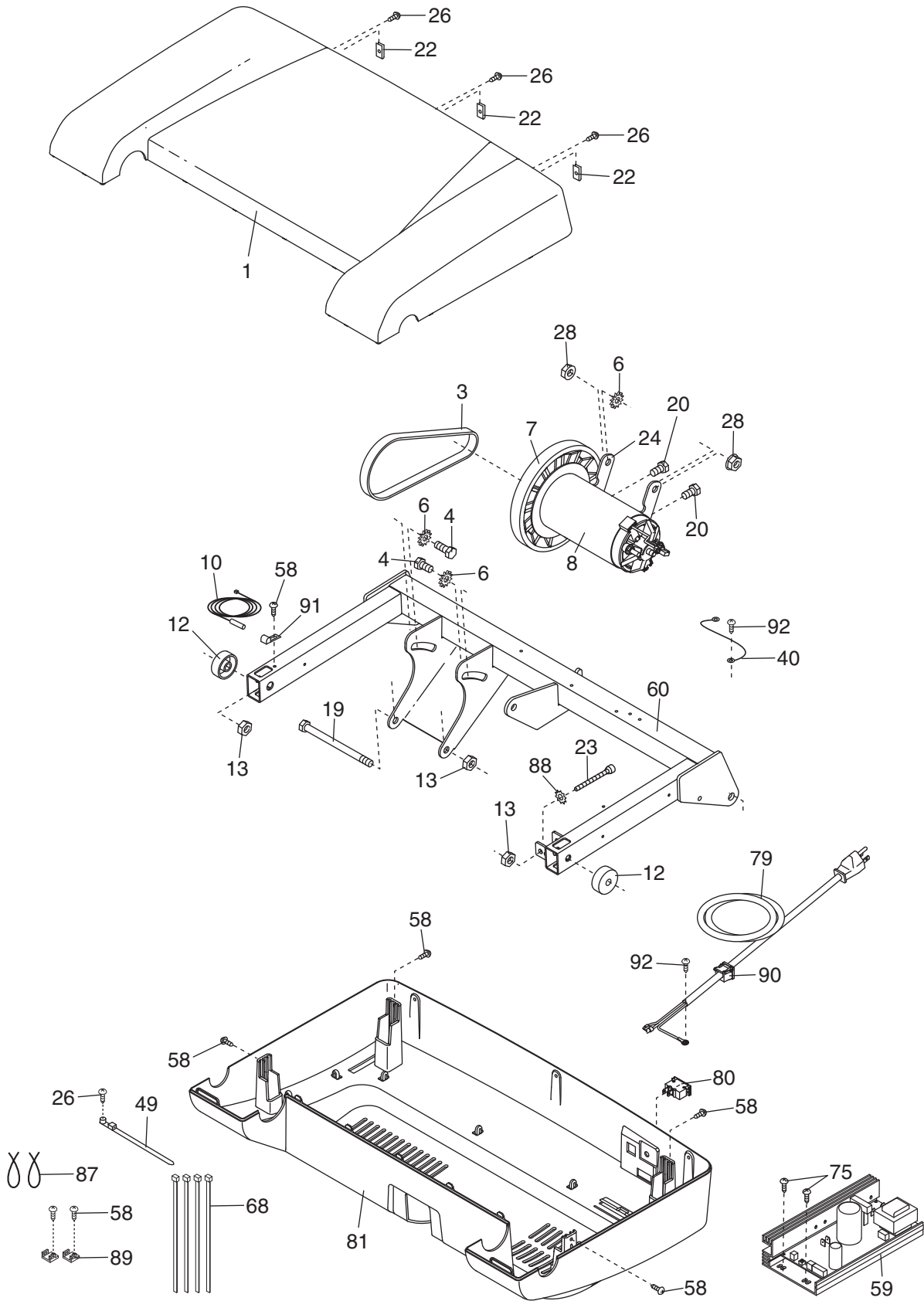

EXPLODED DRAWING C—Model No. 831.24633.0

R0307A

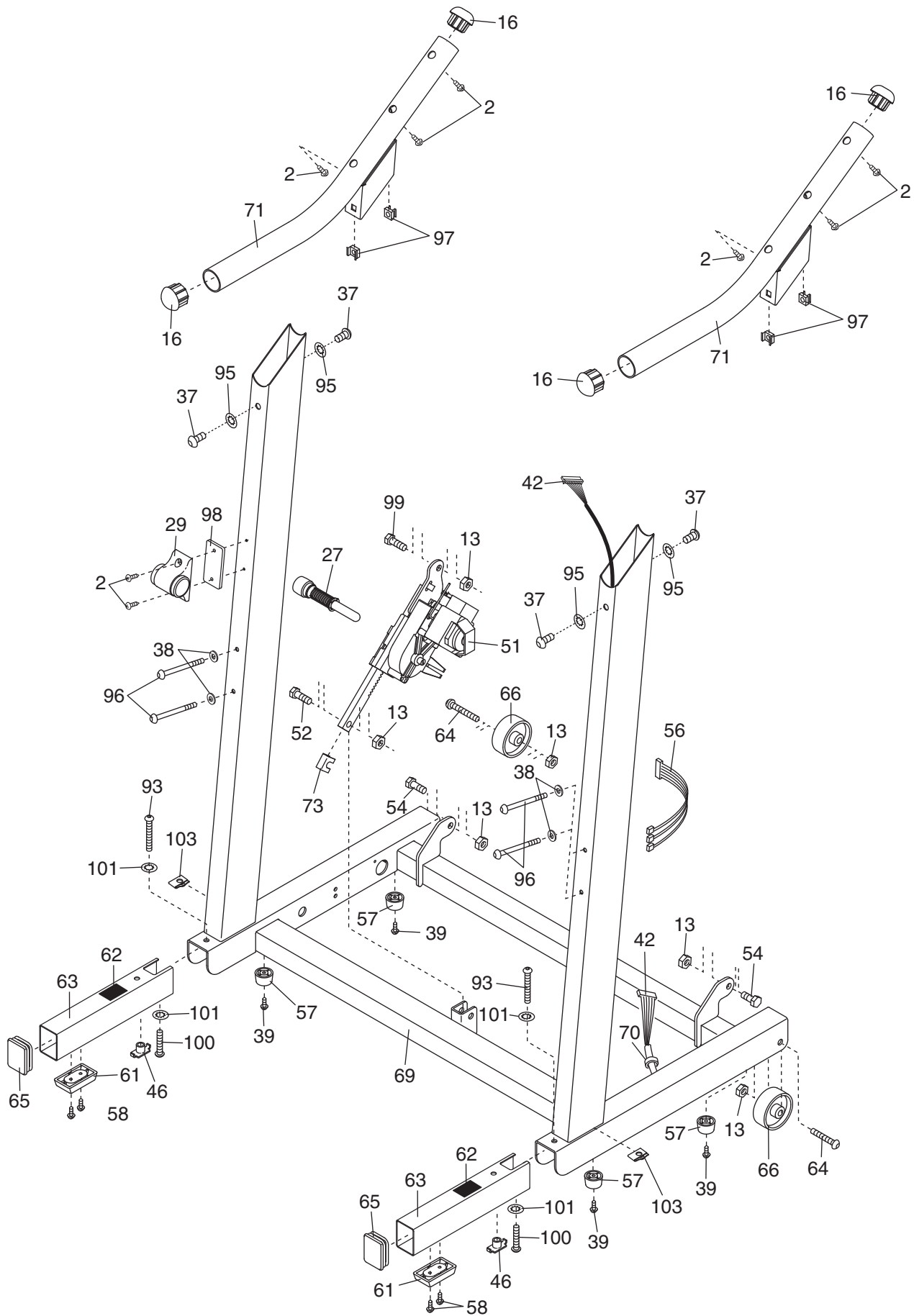

EXPLODED DRAWING D—Model No. 831.24633.0

R0307A

