

# EXPLODED DRAWING A—Model No. 831.24655.1

R1106A

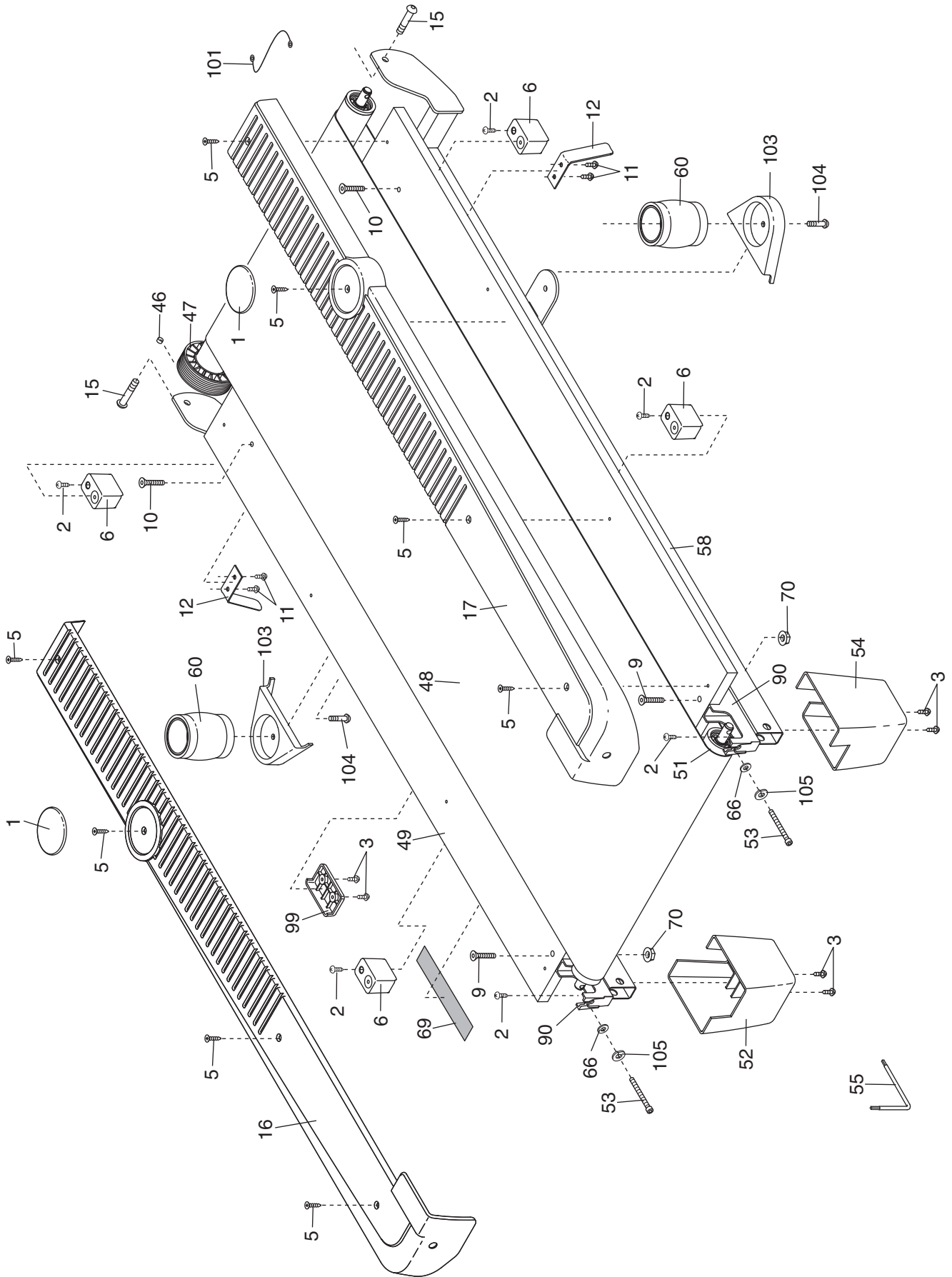

# EXPLODED DRAWING B—Model No. 831.24655.1

R1106A

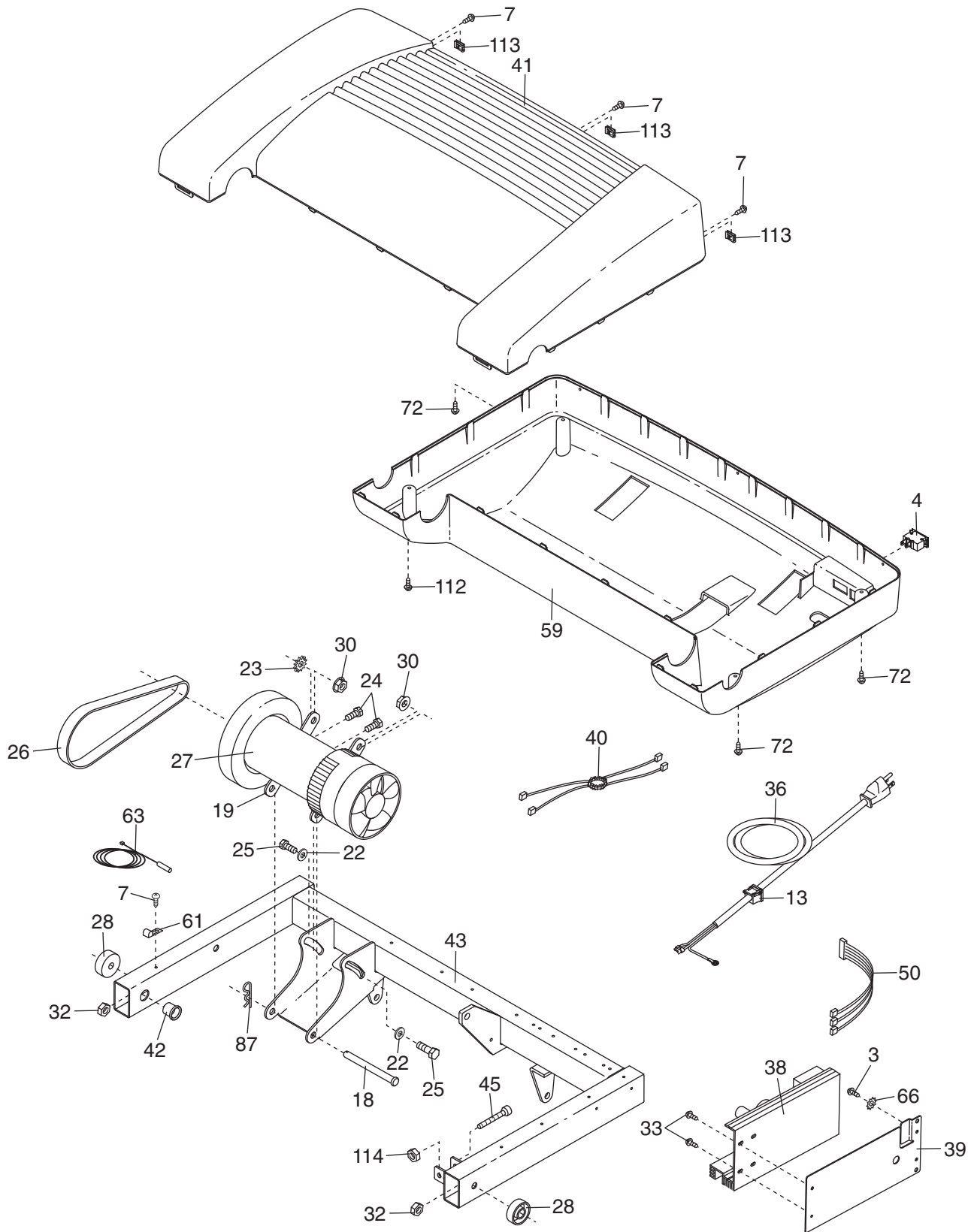

# EXPLODED DRAWING C—Model No. 831.24655.1

R1106A

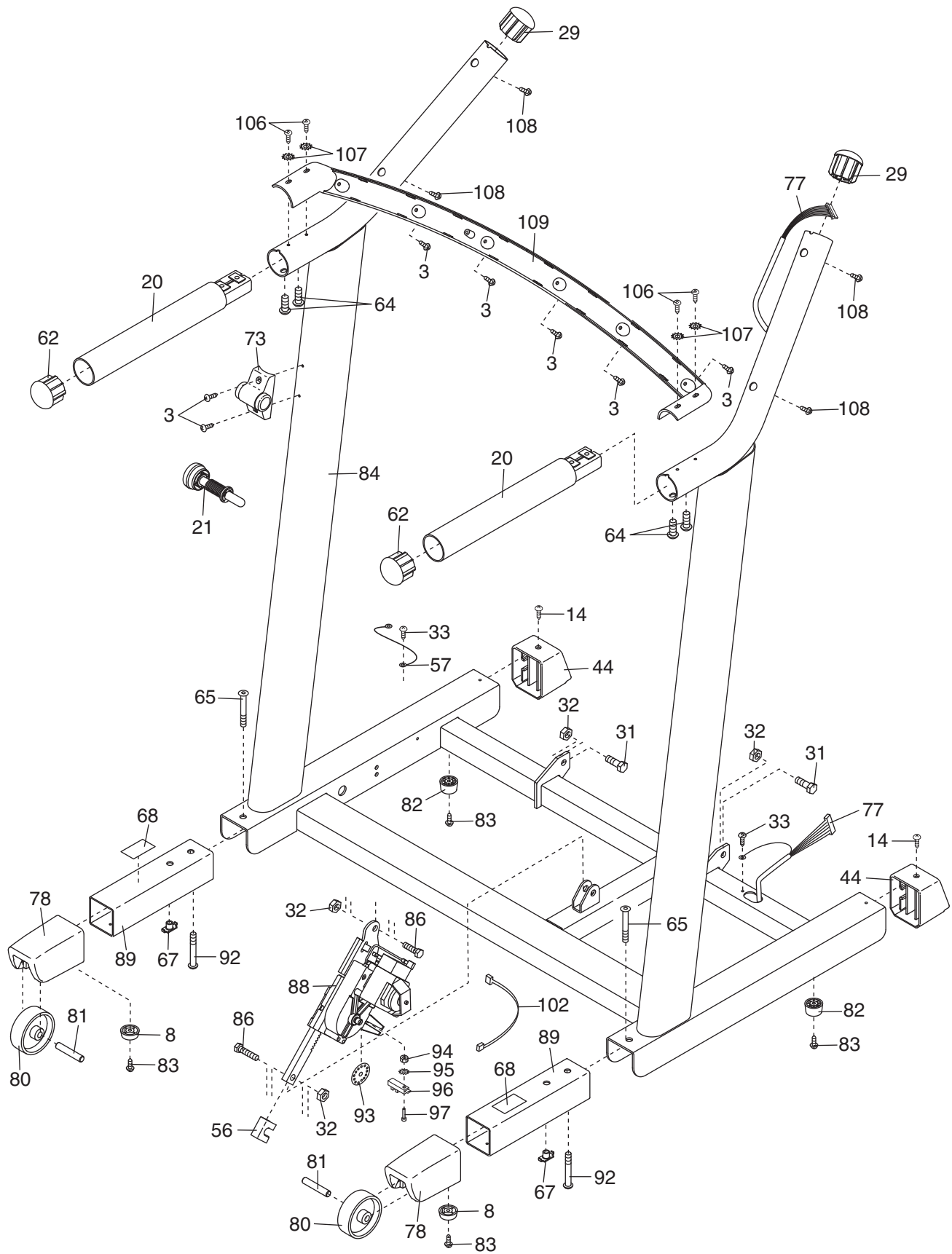

# EXPLODED DRAWING D—Model No. 831.24655.1

R1106A

