

EXPLODED DRAWING B—Model No. 831.24723.1

R0707A

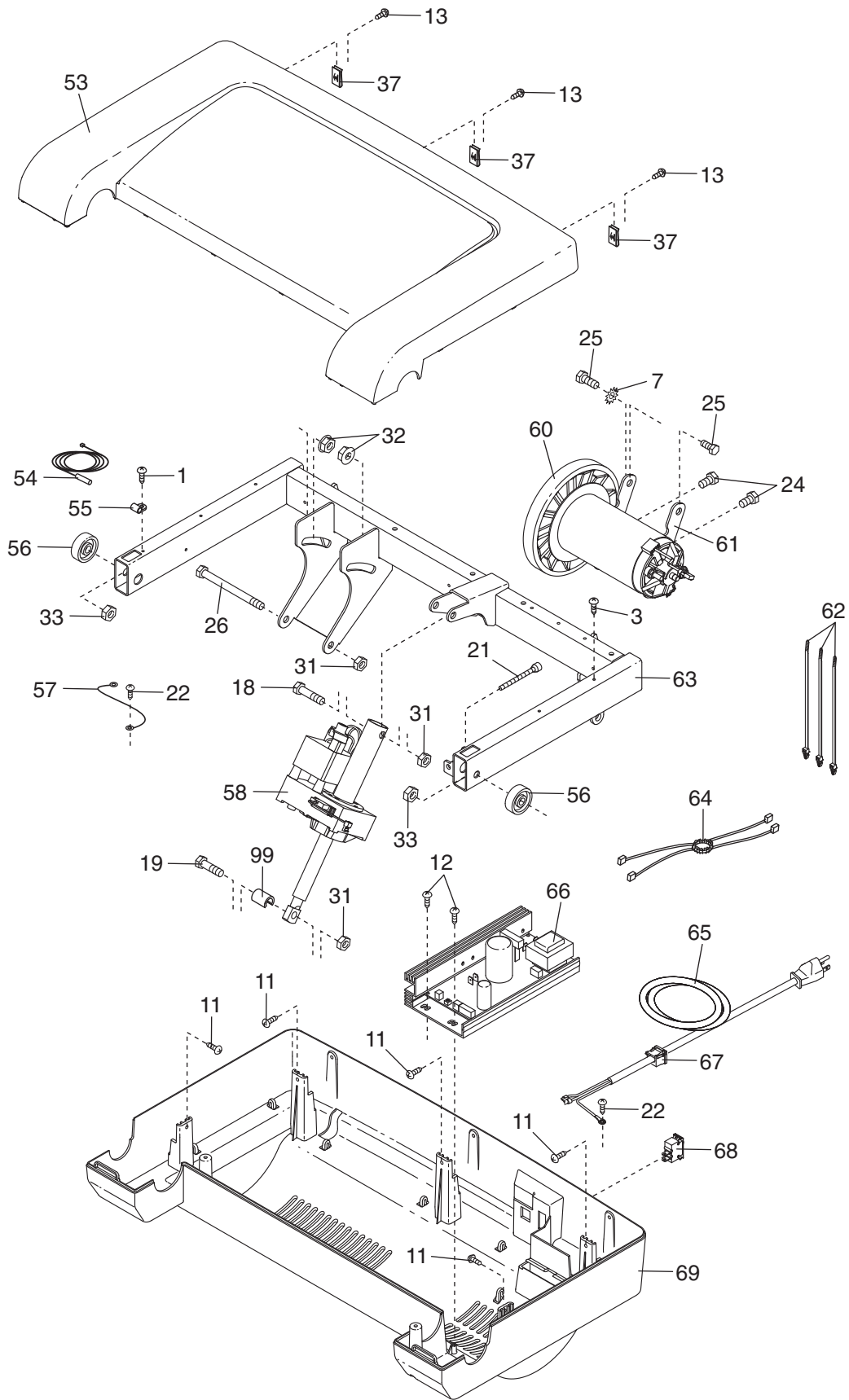

EXPLODED DRAWING C—Model No. 831.24723.1

R0707A

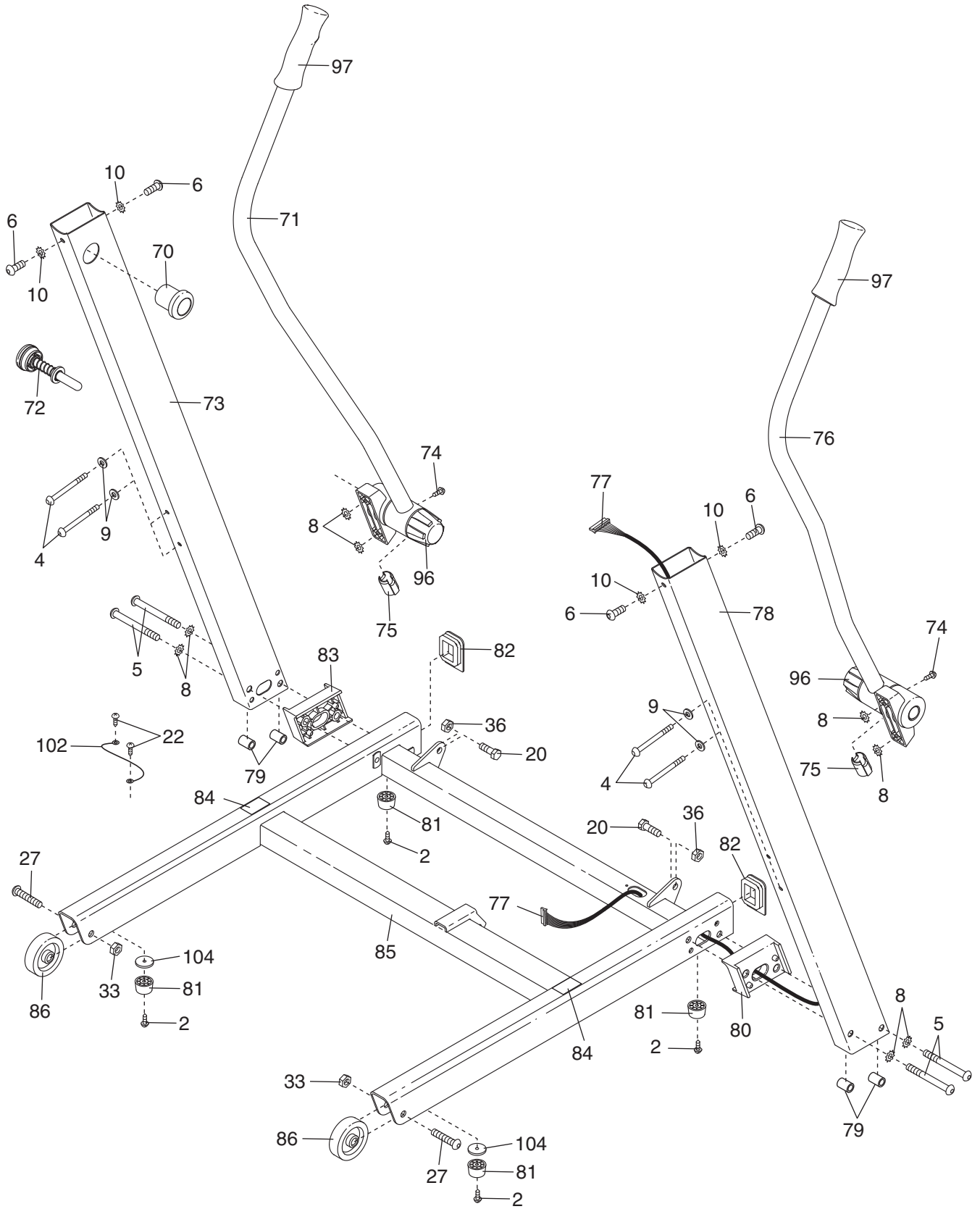

EXPLODED DRAWING D—Model No. 831.24723.1

R0707A

