

EXPLODED DRAWING B—Model No. 831.24723.6

R0707A

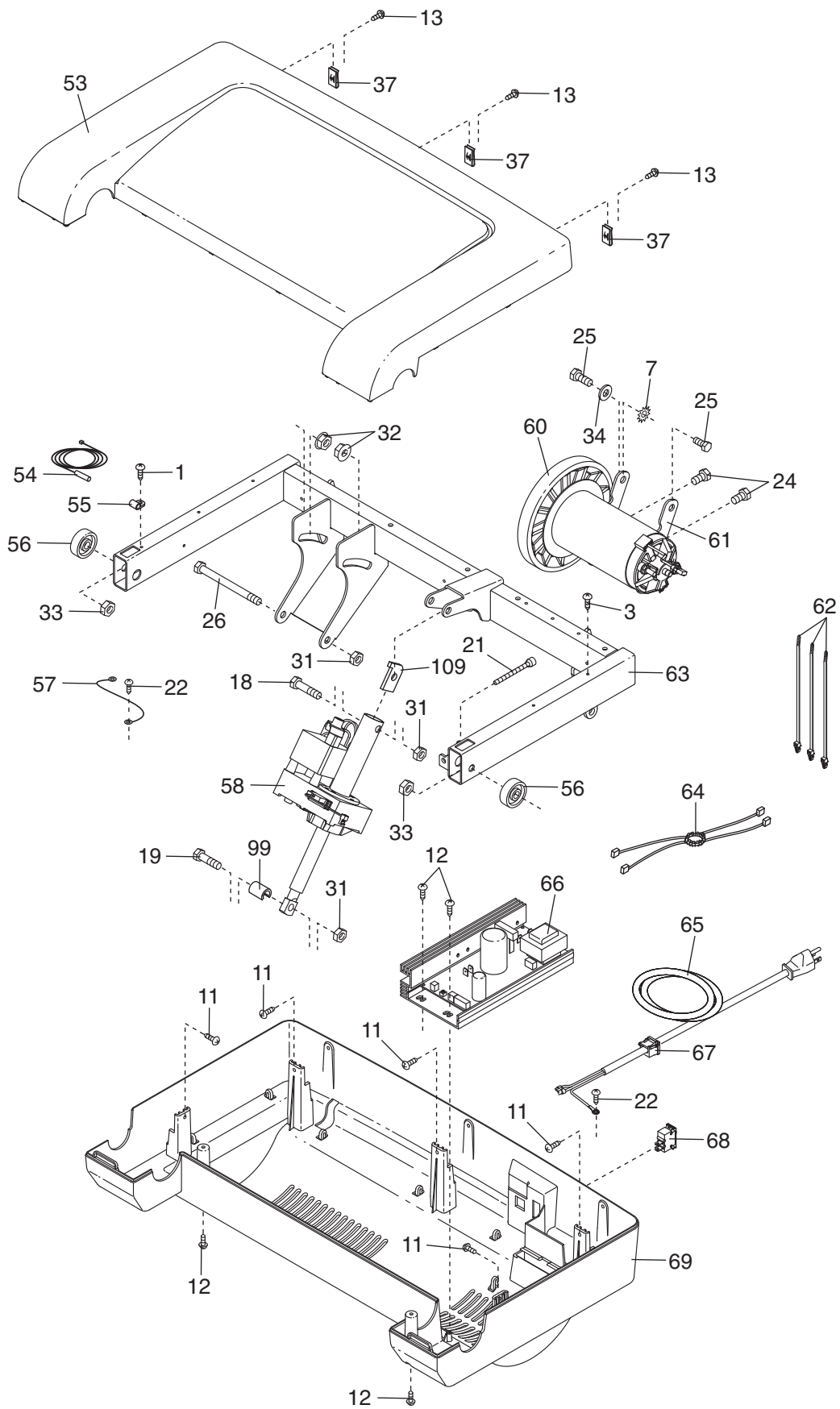

EXPLODED DRAWING C—Model No. 831.24723.6

R0707A

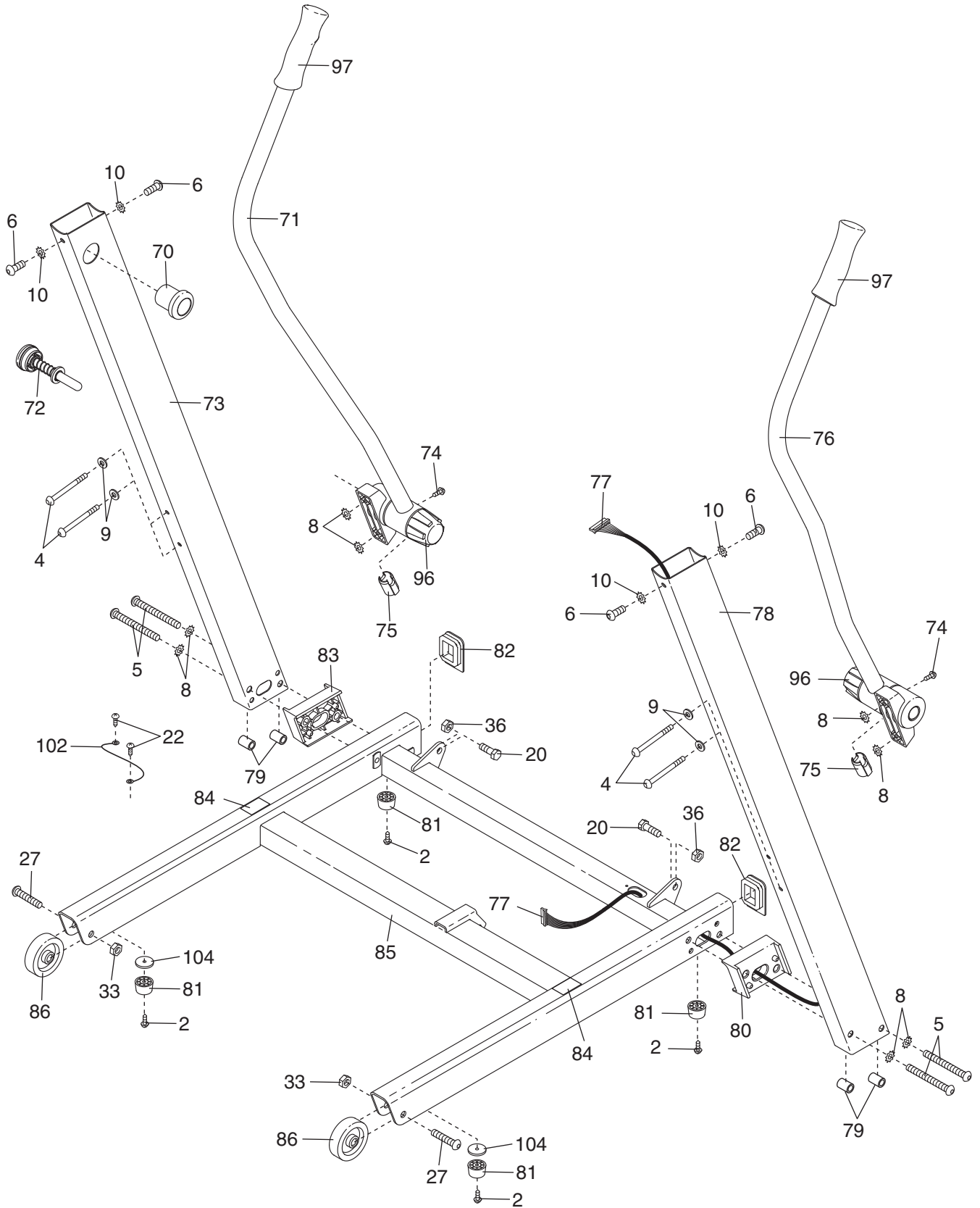

EXPLODED DRAWING D—Model No. 831.24723.6

R0707A

