

EXPLODED DRAWING B—Model No. 831.24723.7

R0208A

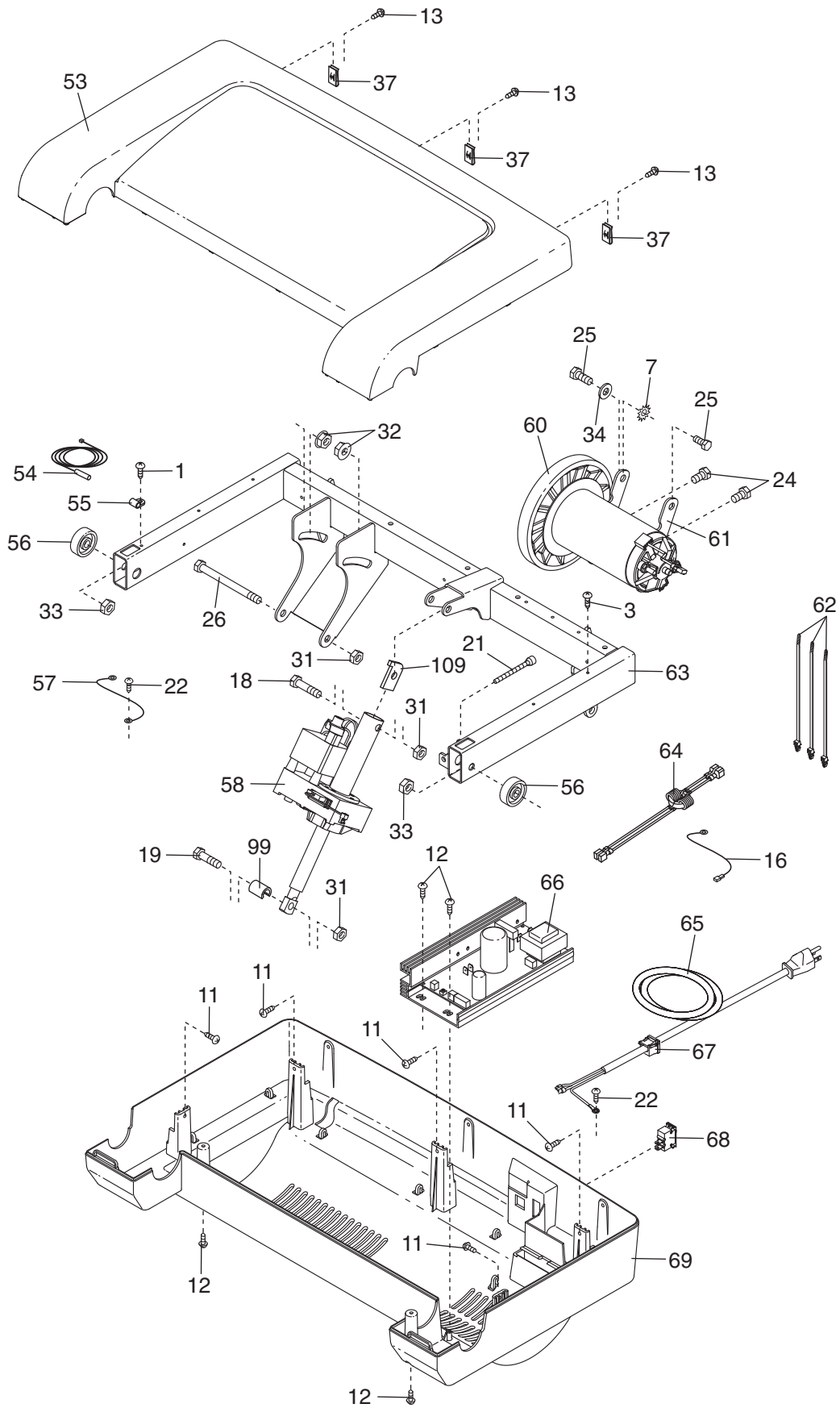

EXPLODED DRAWING C—Model No. 831.24723.7

R0208A

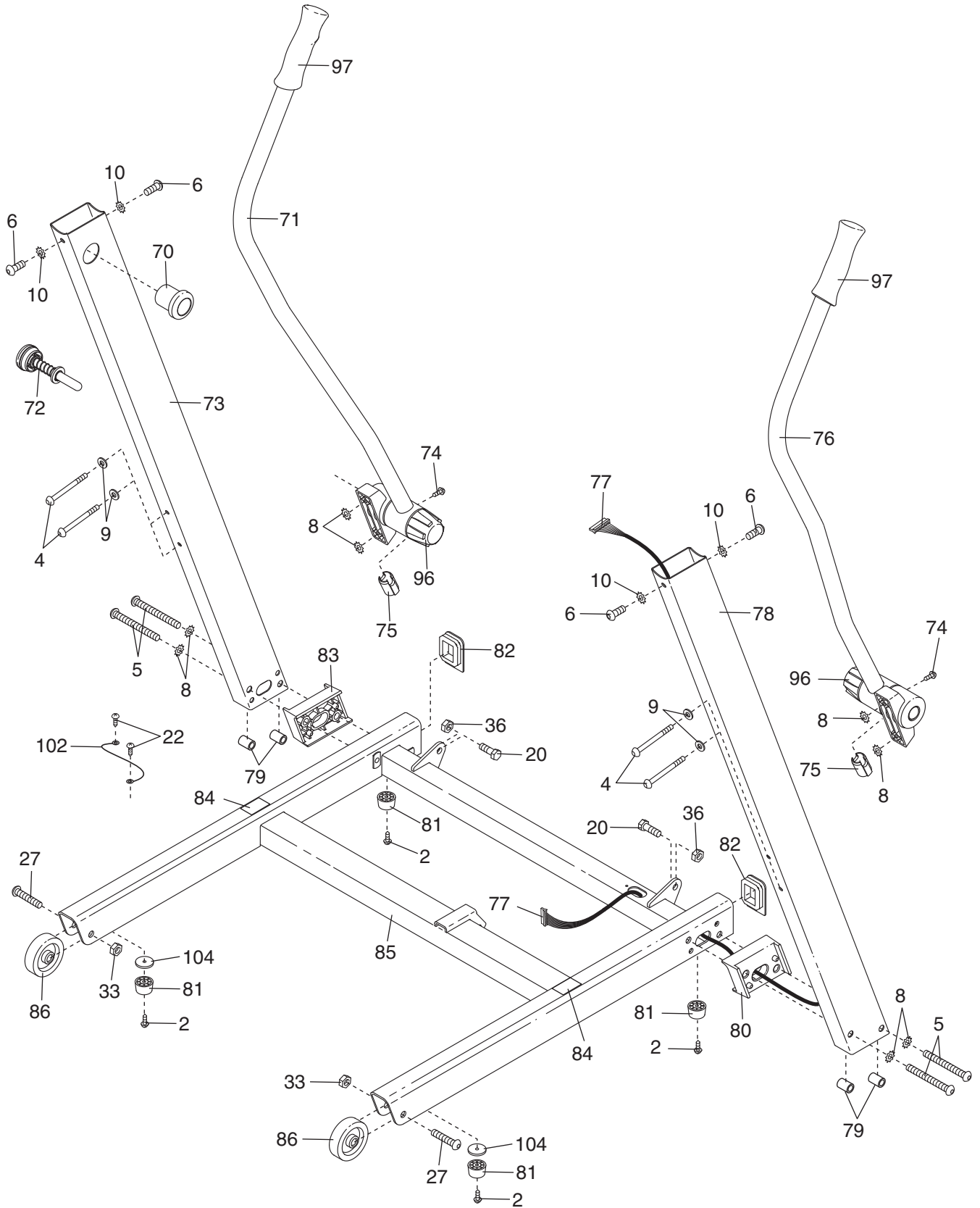

EXPLODED DRAWING D—Model No. 831.24723.7

R0208A

