

EXPLODED DRAWING A—Model No. 831.24723.9

R0508A

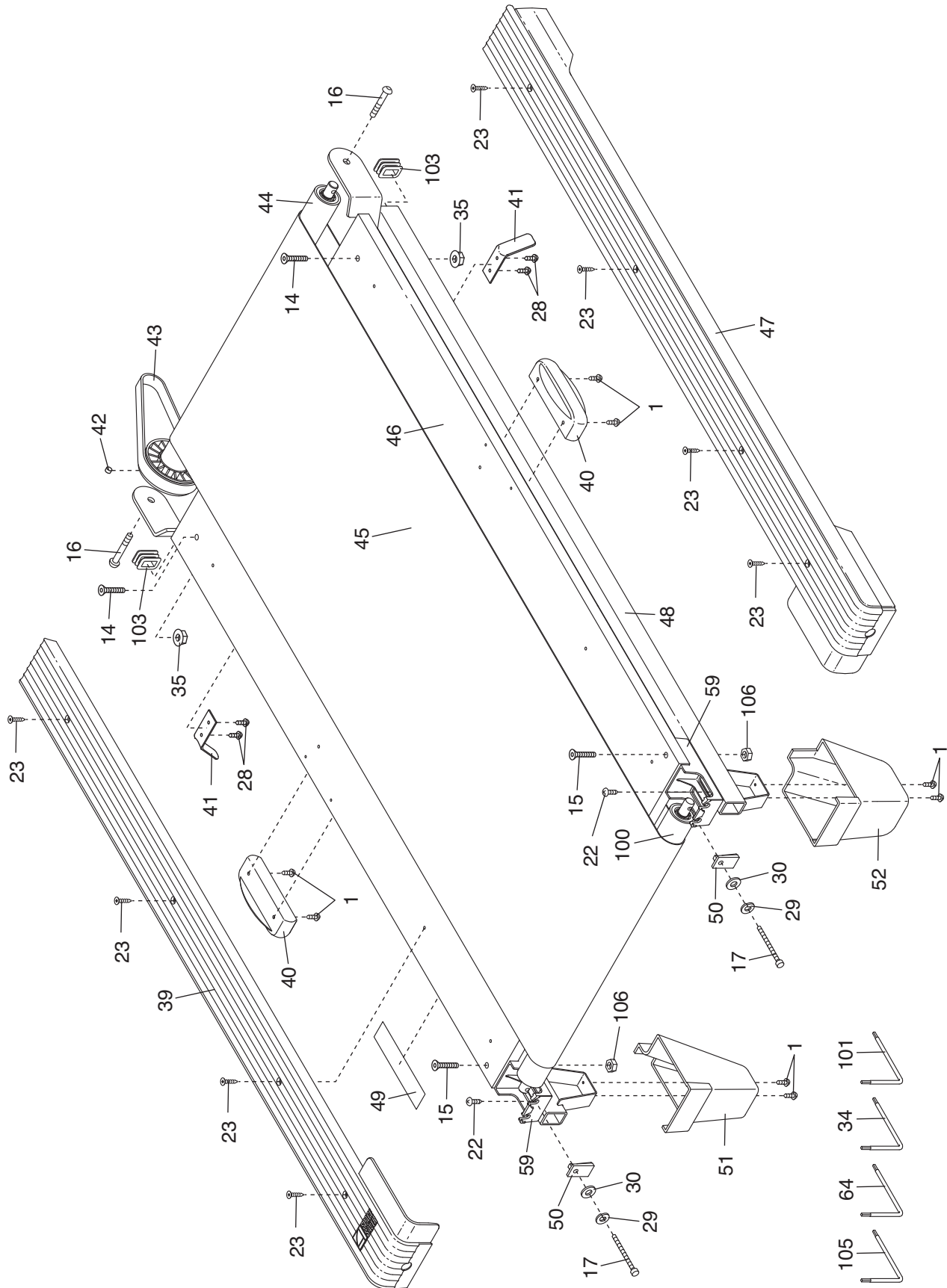

EXPLODED DRAWING B—Model No. 831.24723.9

R0508A

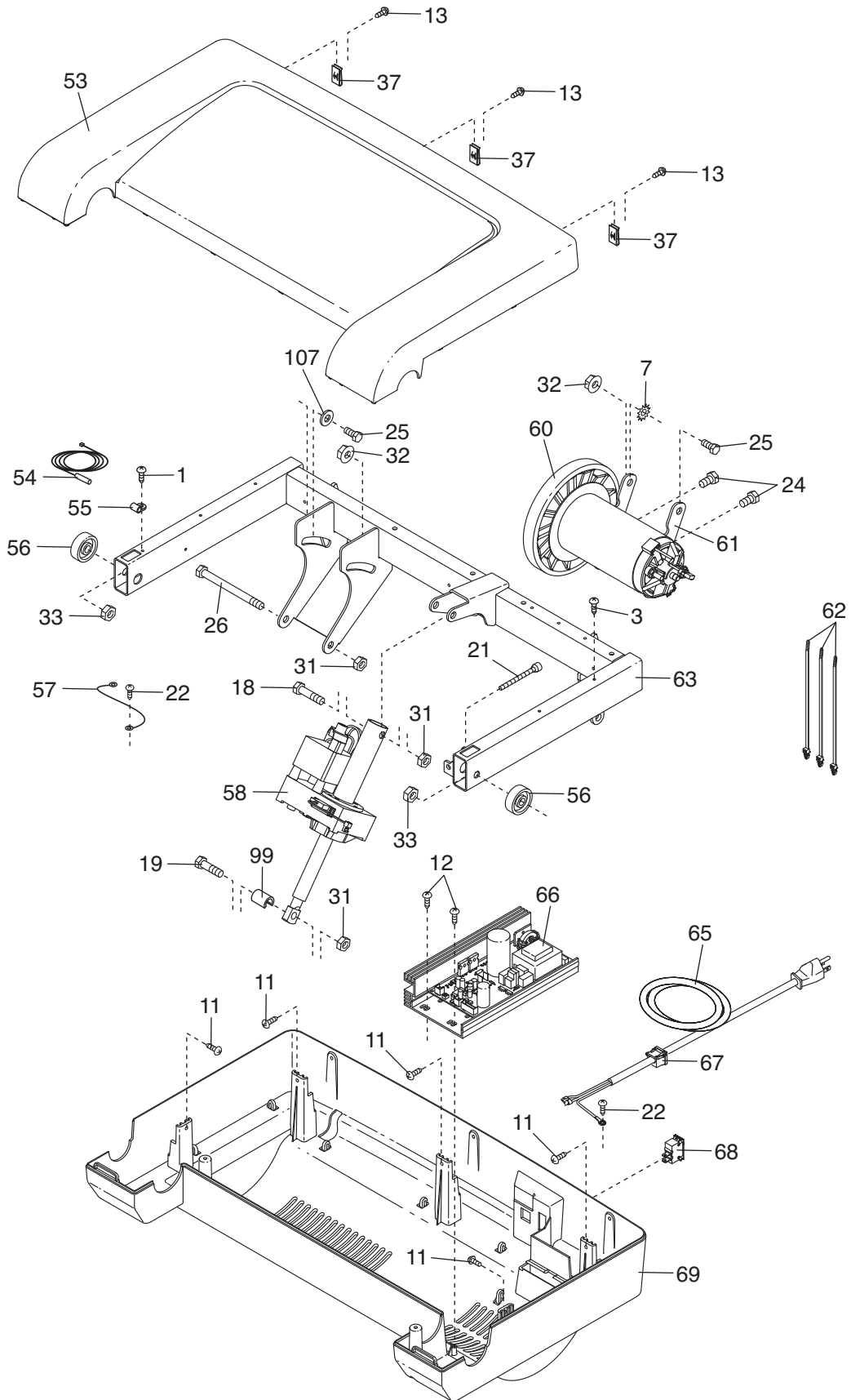

EXPLODED DRAWING C—Model No. 831.24723.9

R0508A

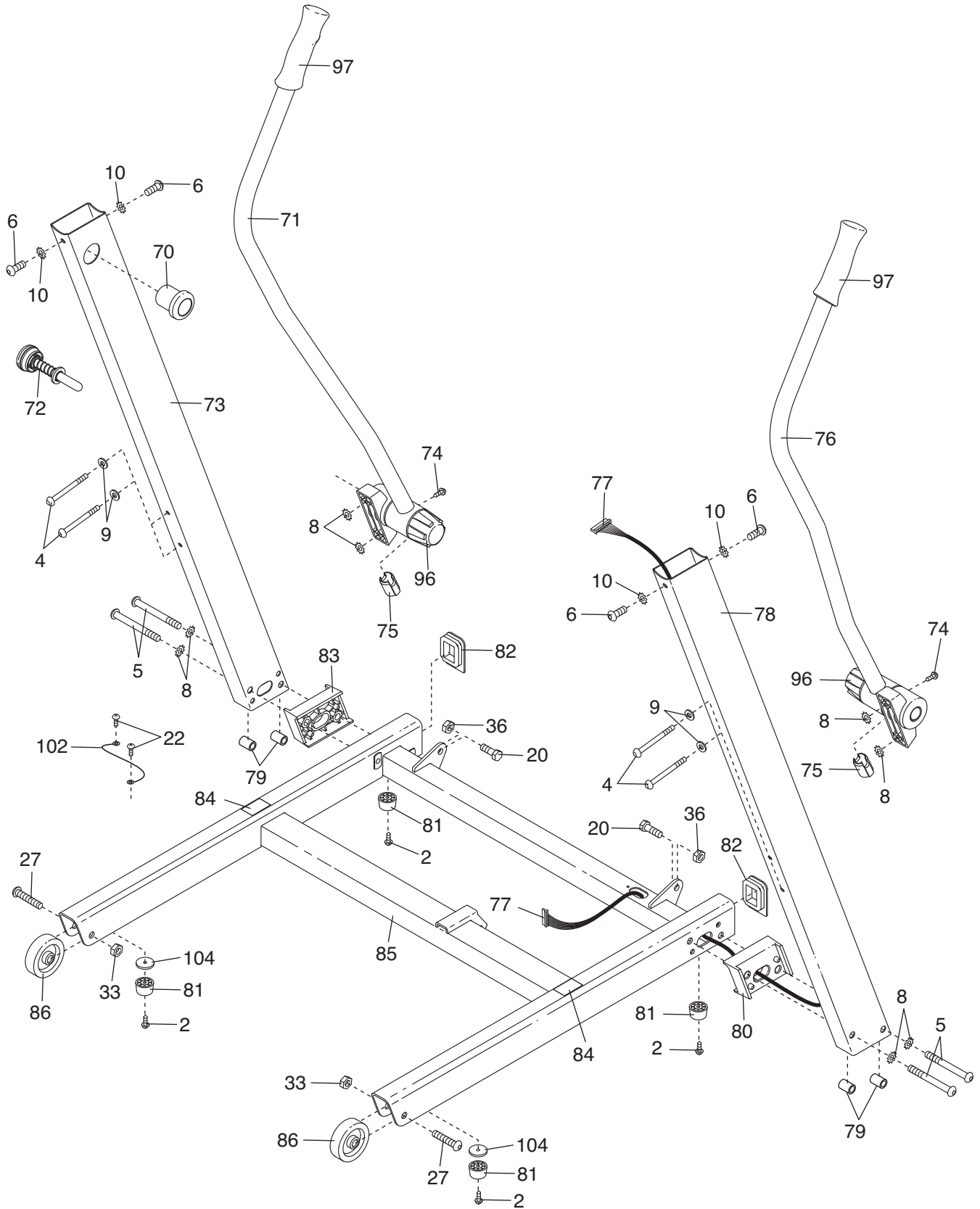

EXPLODED DRAWING D—Model No. 831.24723.9

R0508A

