

EXPLODED DRAWING A—Model No. 831.24745.0

R0407B

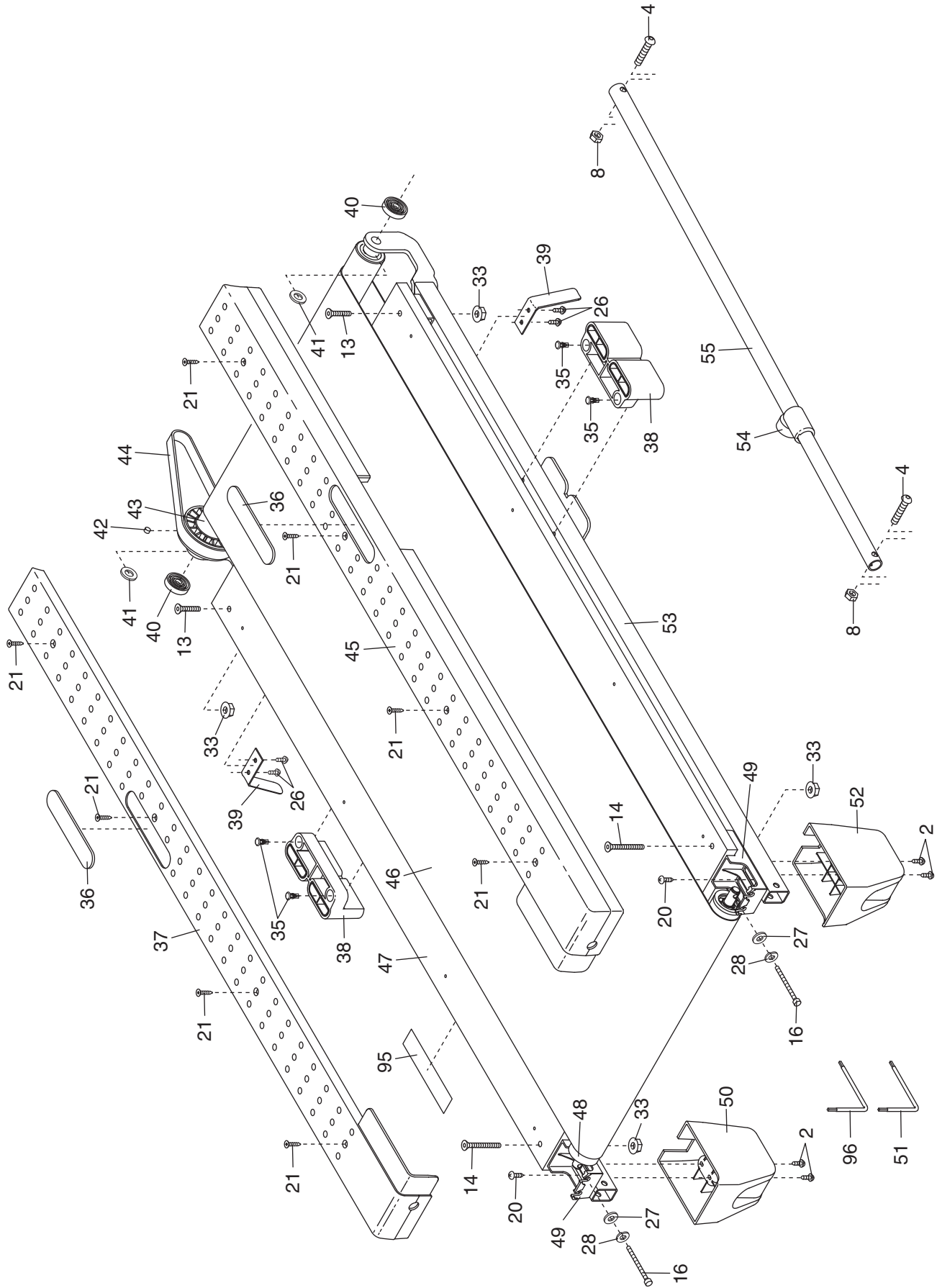

EXPLODED DRAWING B—Model No. 831.24745.0

R0407B

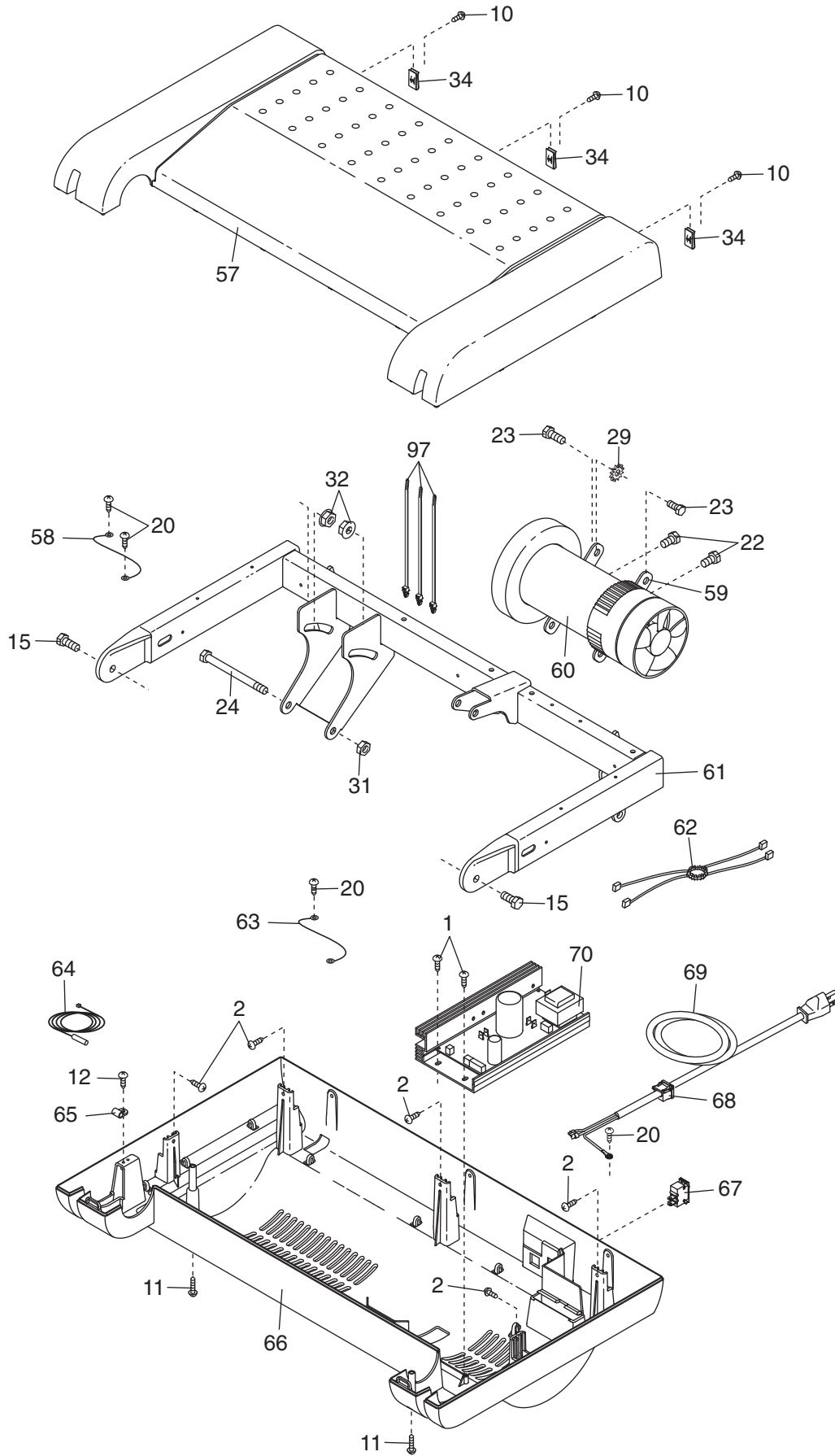

EXPLODED DRAWING C—Model No. 831.24745.0

R0407B

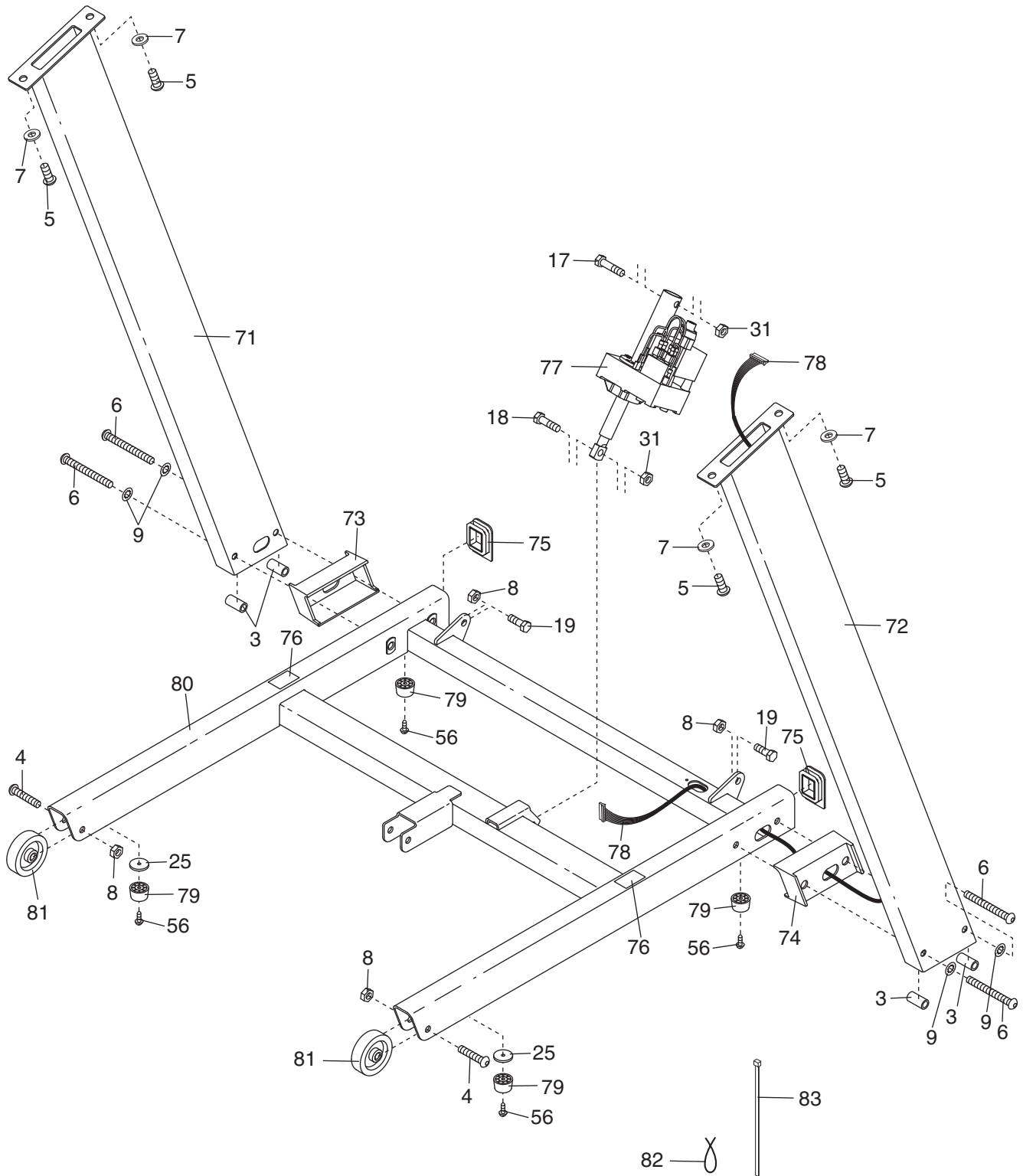

EXPLODED DRAWING D—Model No. 831.24745.0

R0407B

