

EXPLODED DRAWING B—Model No. 831.24745.6

R0108A

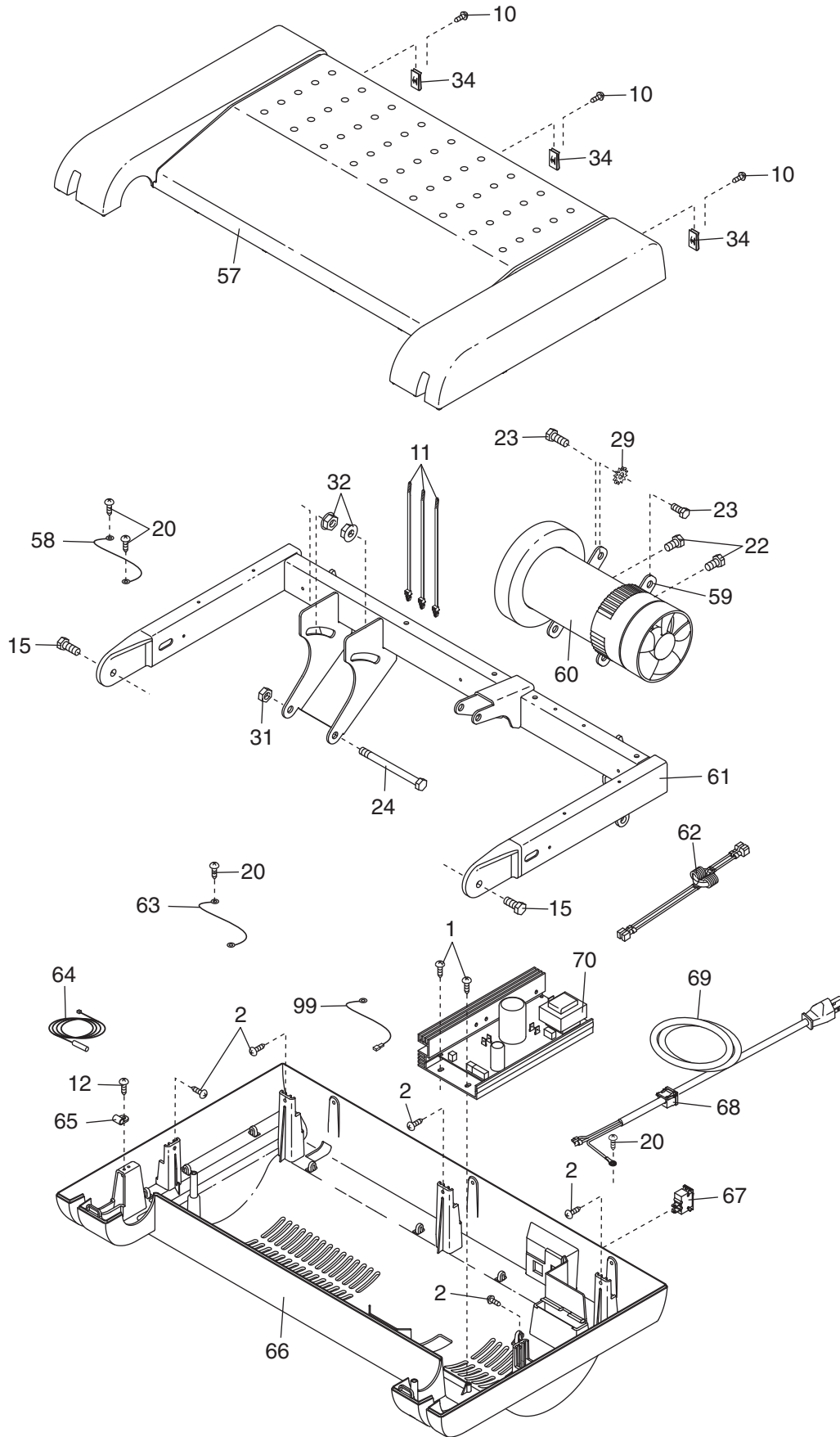

EXPLODED DRAWING C—Model No. 831.24745.6

R0108A

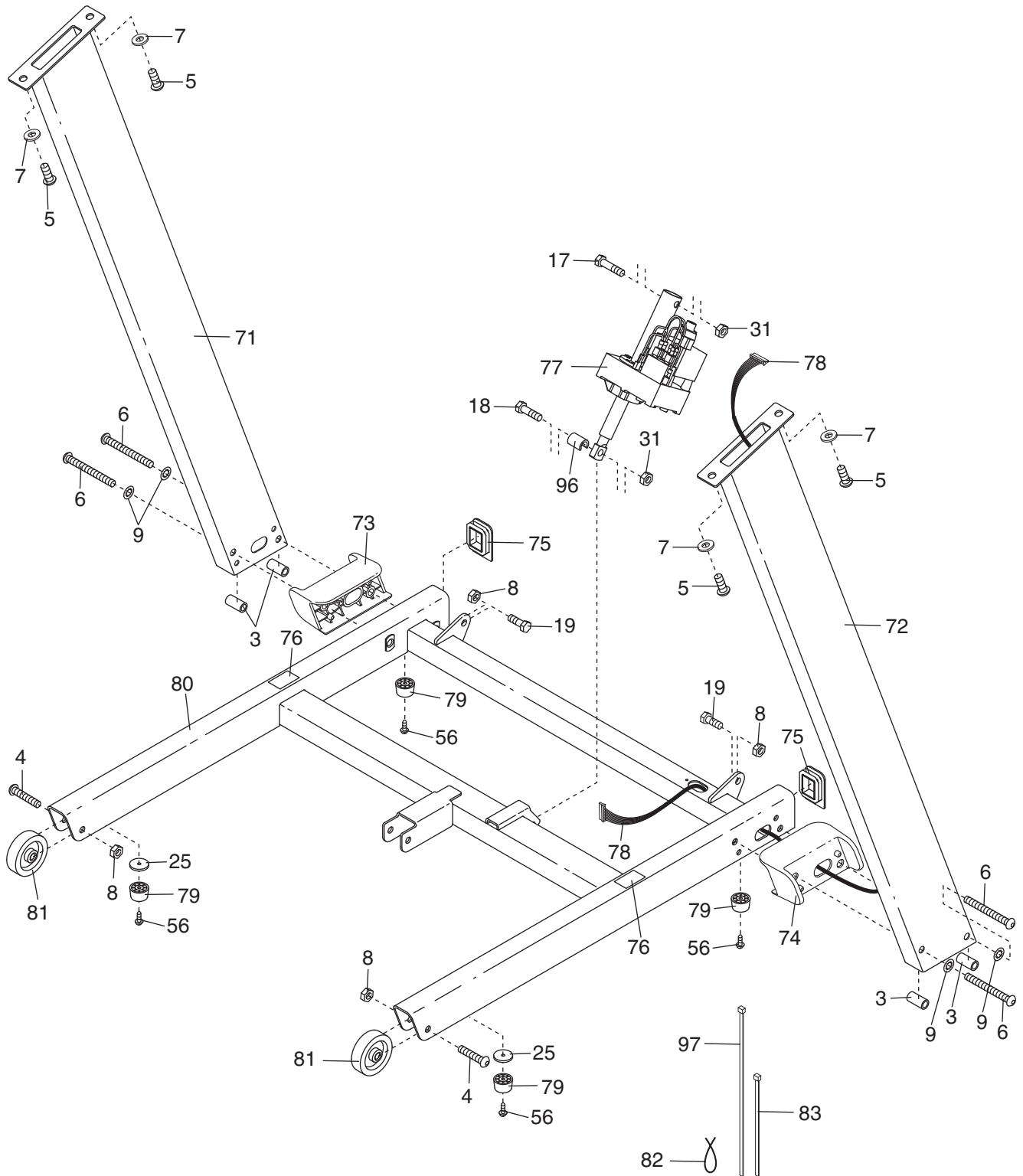

EXPLODED DRAWING D—Model No. 831.24745.6

R0108A

