

# EXPLODED DRAWING A—Model No. 831.24745.2

R0707A

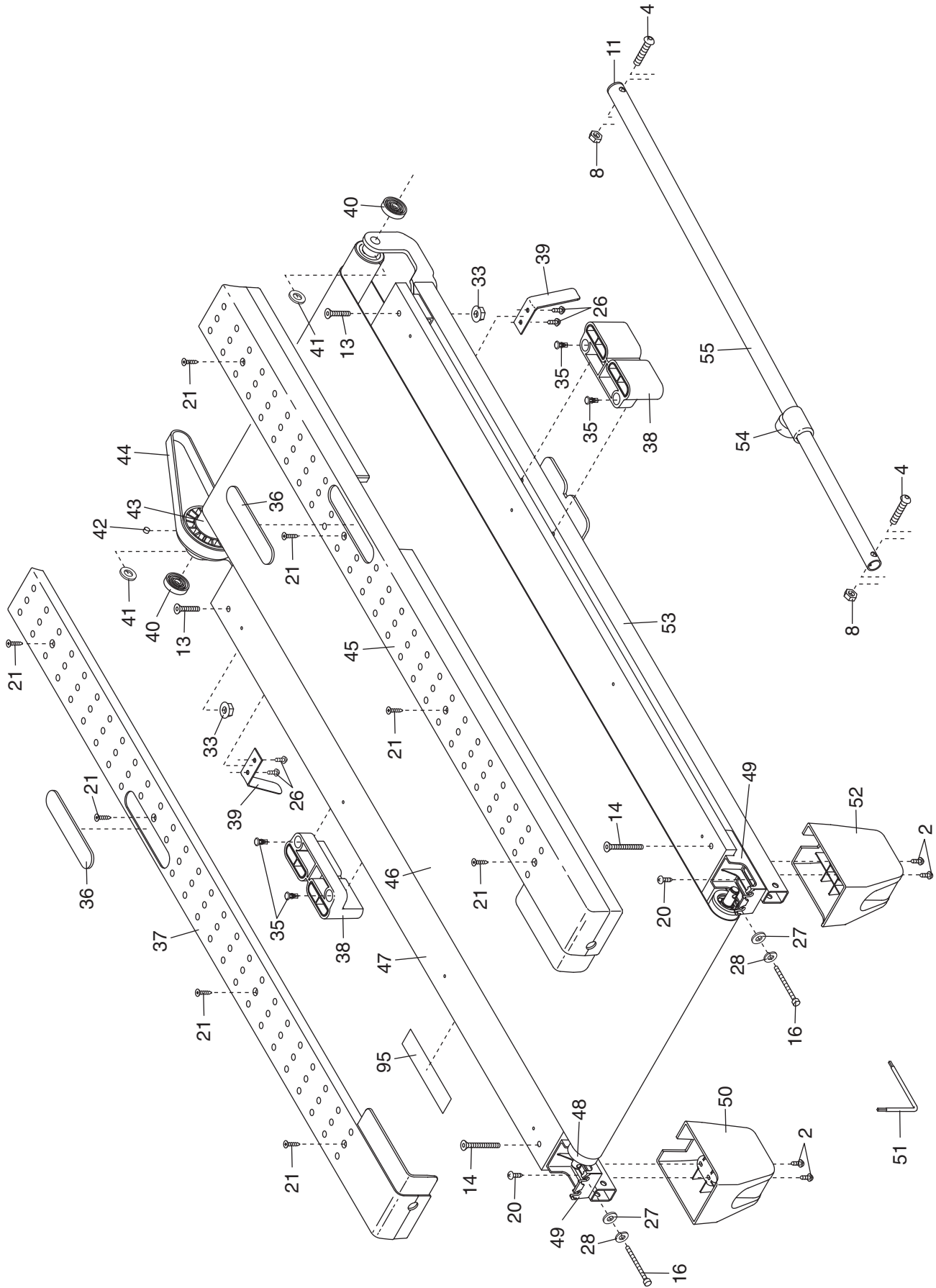

# EXPLODED DRAWING B—Model No. 831.24745.2

R0707A

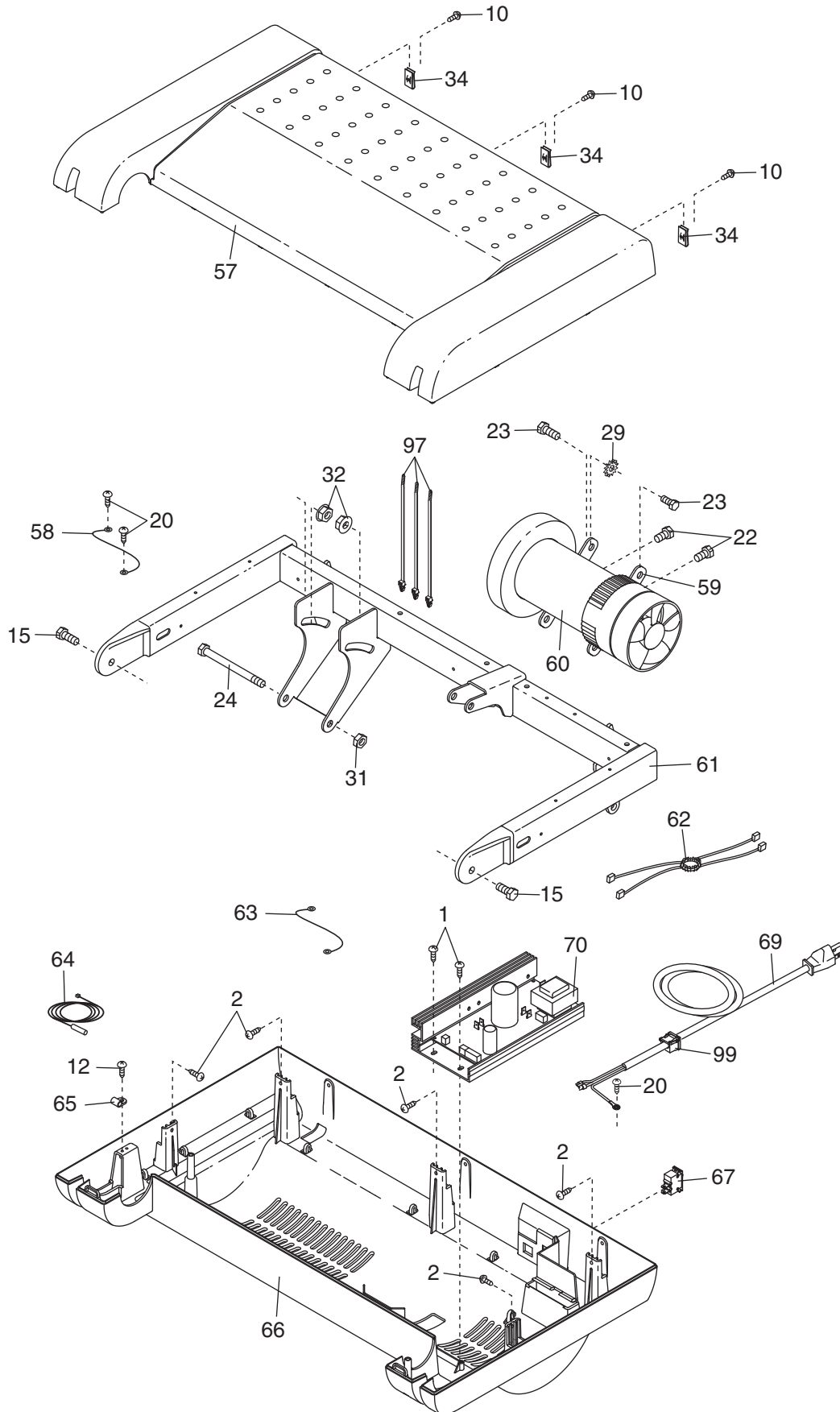

# EXPLODED DRAWING C—Model No. 831.24745.2

R0707A

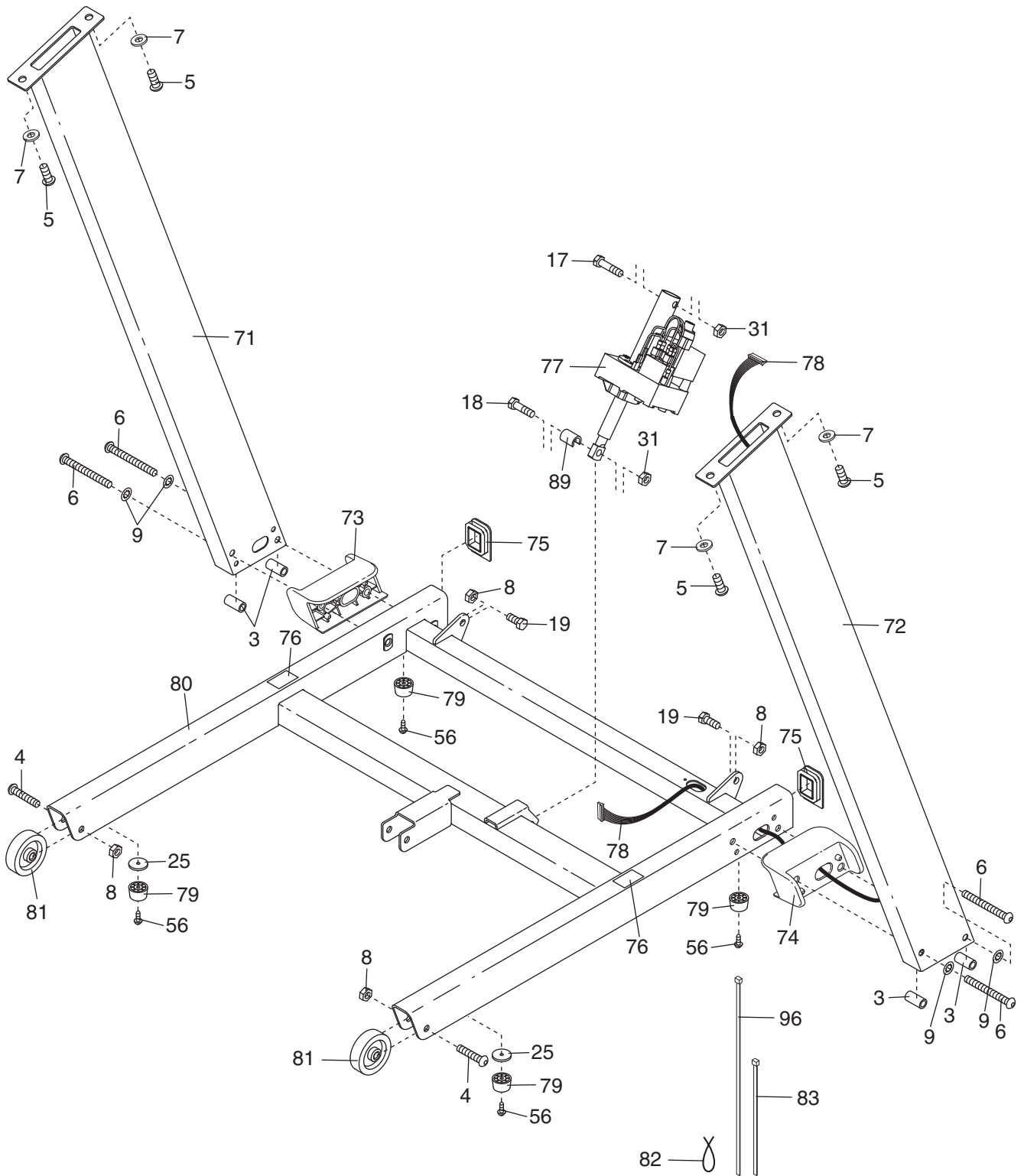

# EXPLODED DRAWING D—Model No. 831.24745.2

R0707A

