

# EXPLODED DRAWING A—Model No. NTL15008.0

R0409A

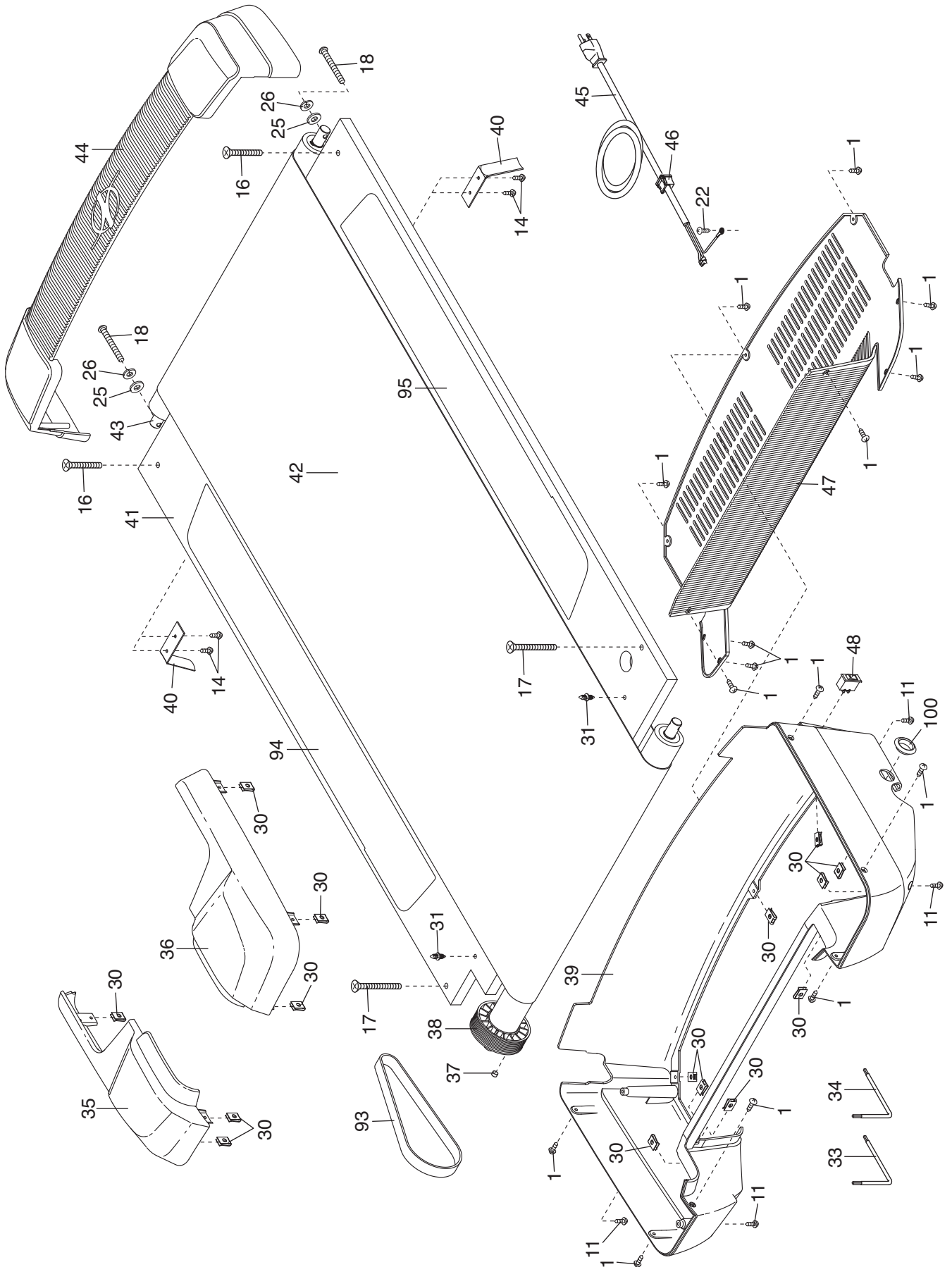

# EXPLODED DRAWING B—Model No. NTL15008.0

R0409A

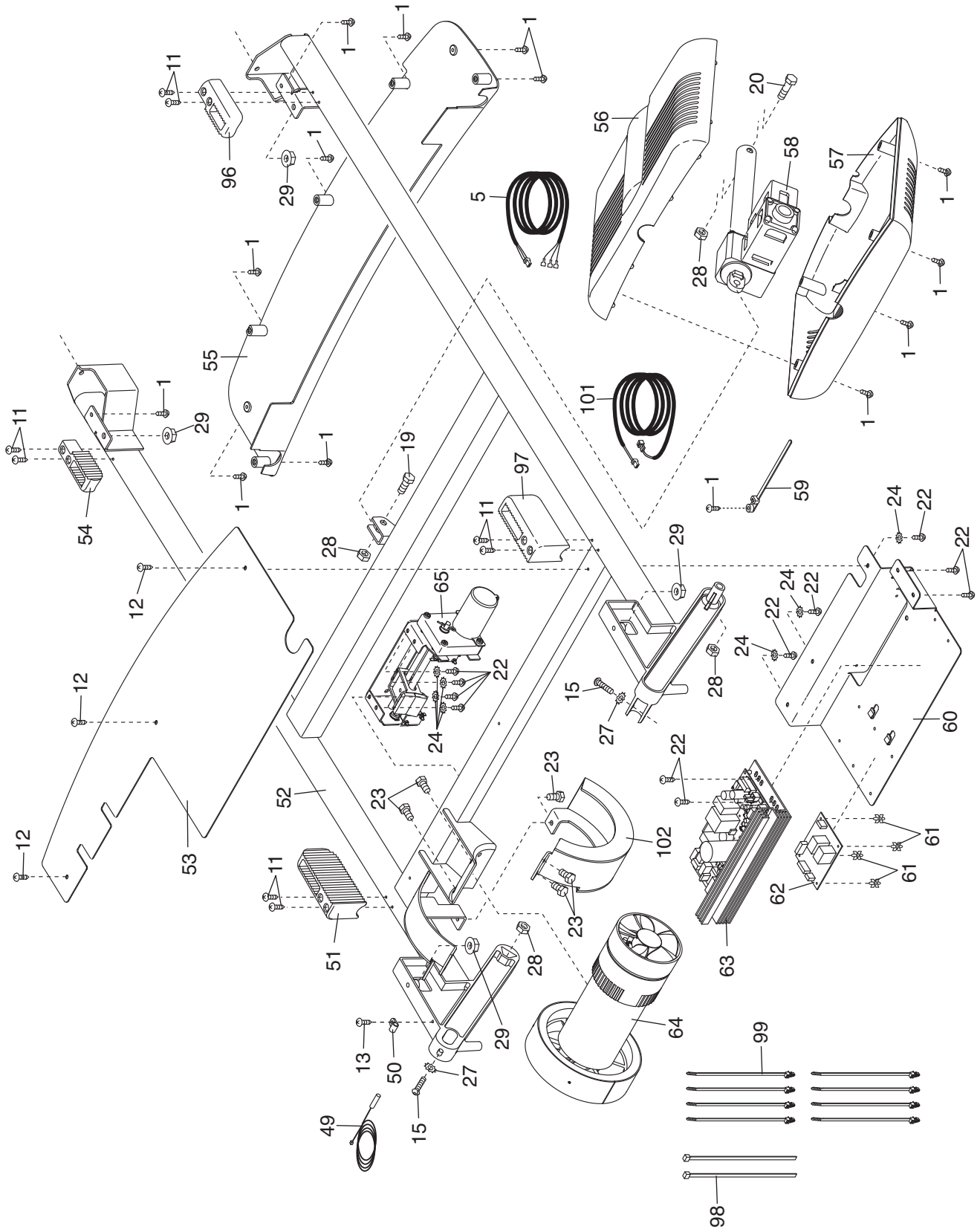

# EXPLODED DRAWING C—Model No. NTL15008.0

R0409A

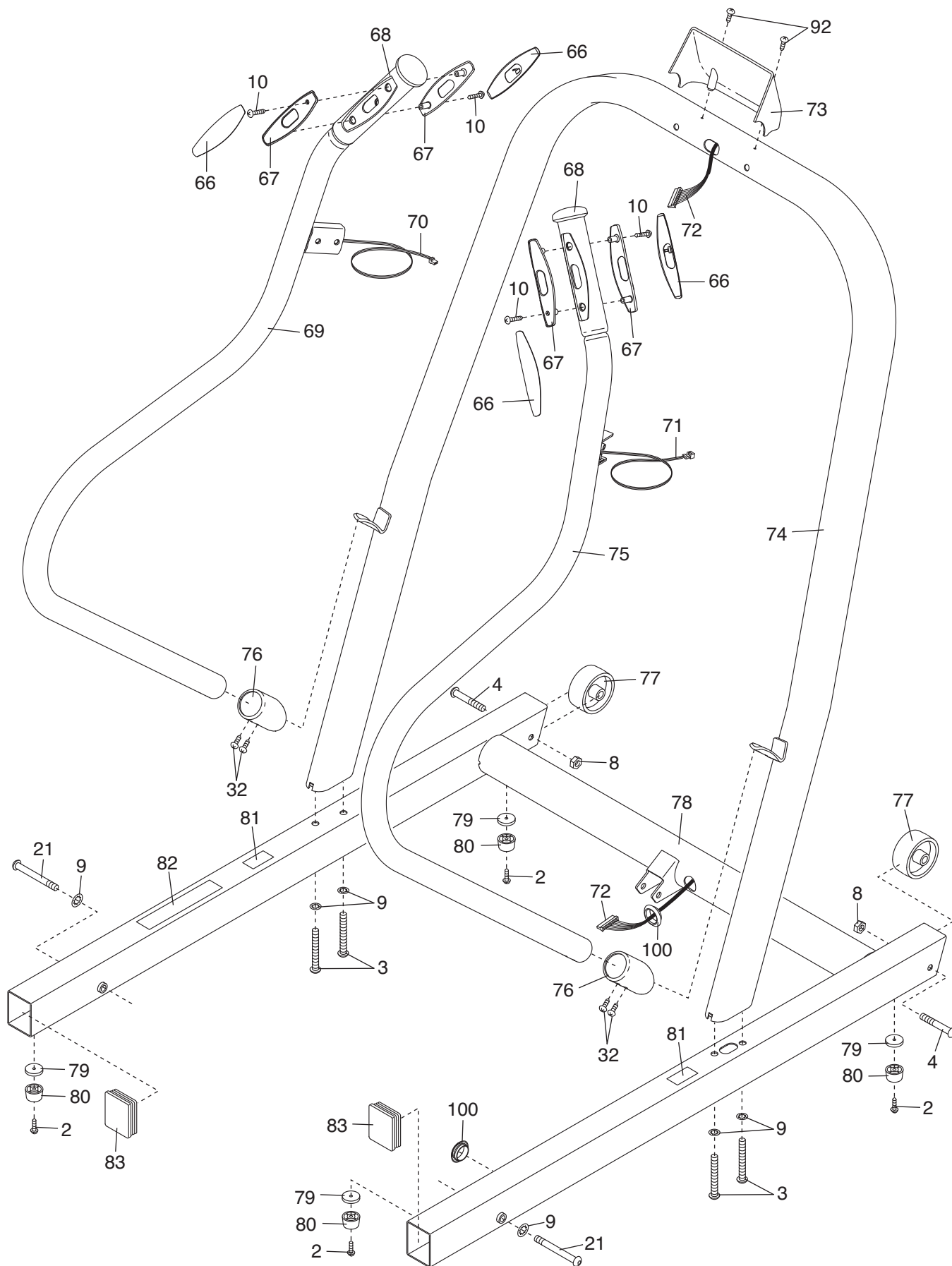

# EXPLODED DRAWING D—Model No. NTL15008.0

R0409A

