

EXPLODED DRAWING A—Model No. NTL15008.1

R0709A

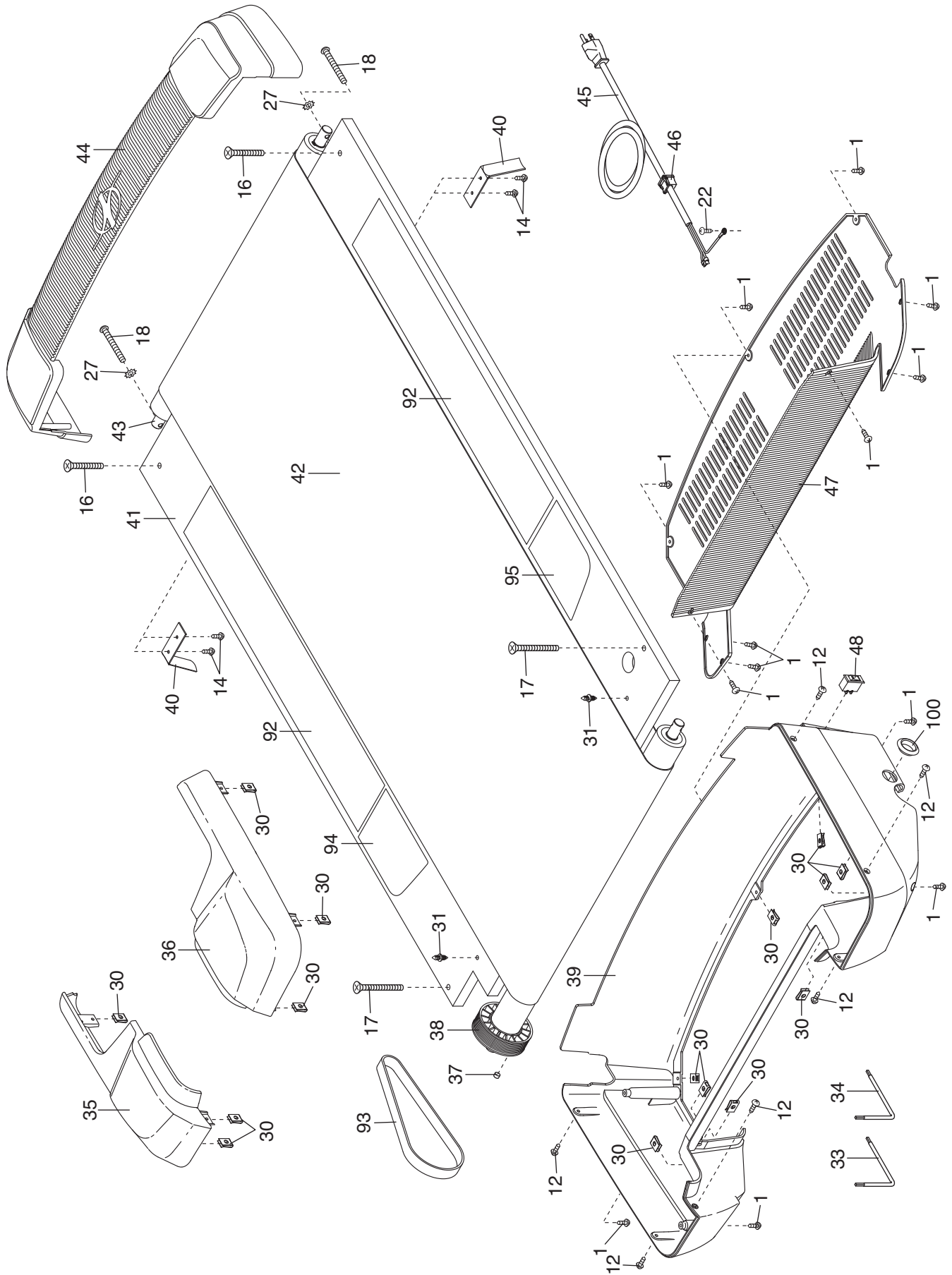

EXPLODED DRAWING B—Model No. NTL15008.1

R0709A

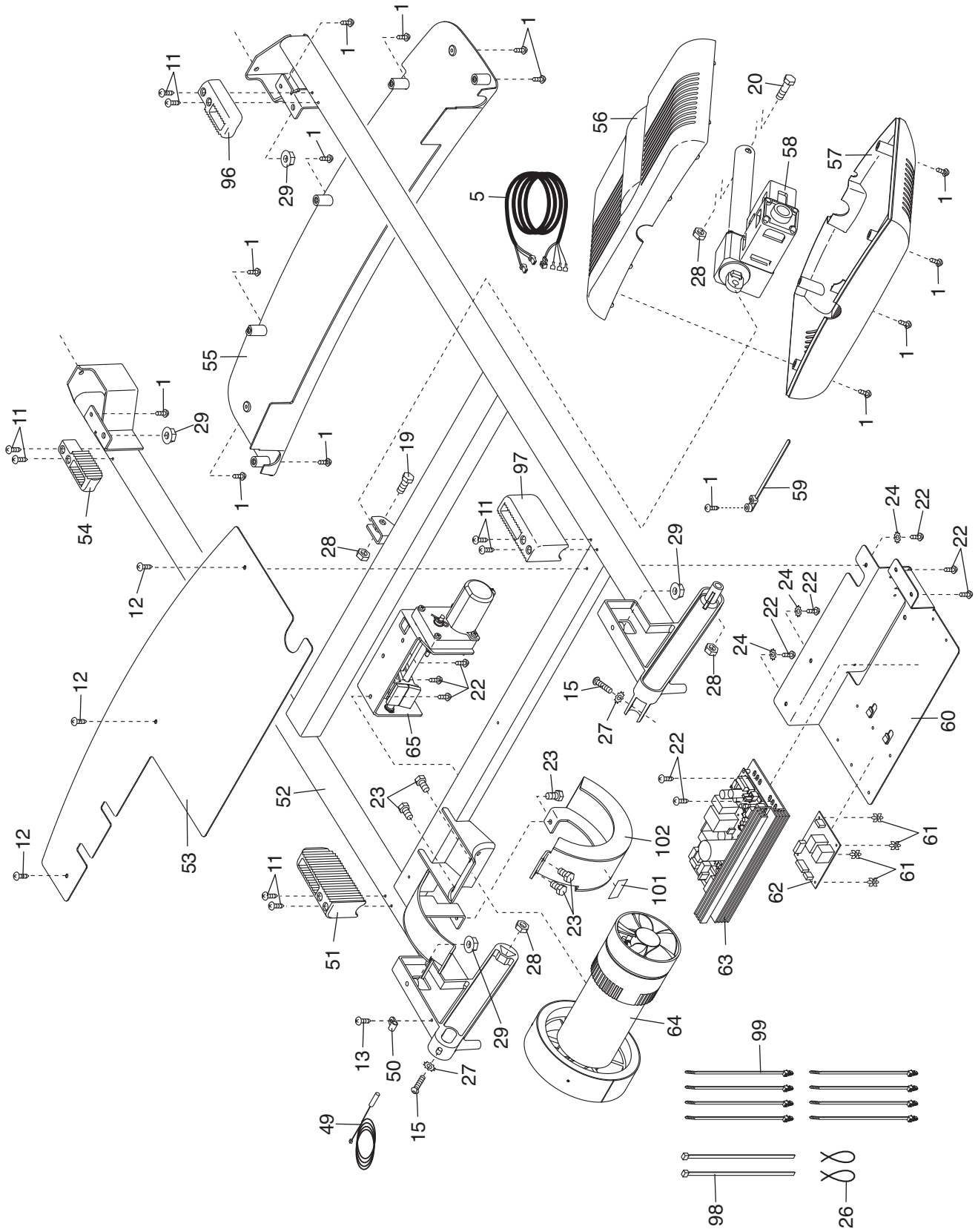

EXPLODED DRAWING C—Model No. NTL15008.1

R0709A

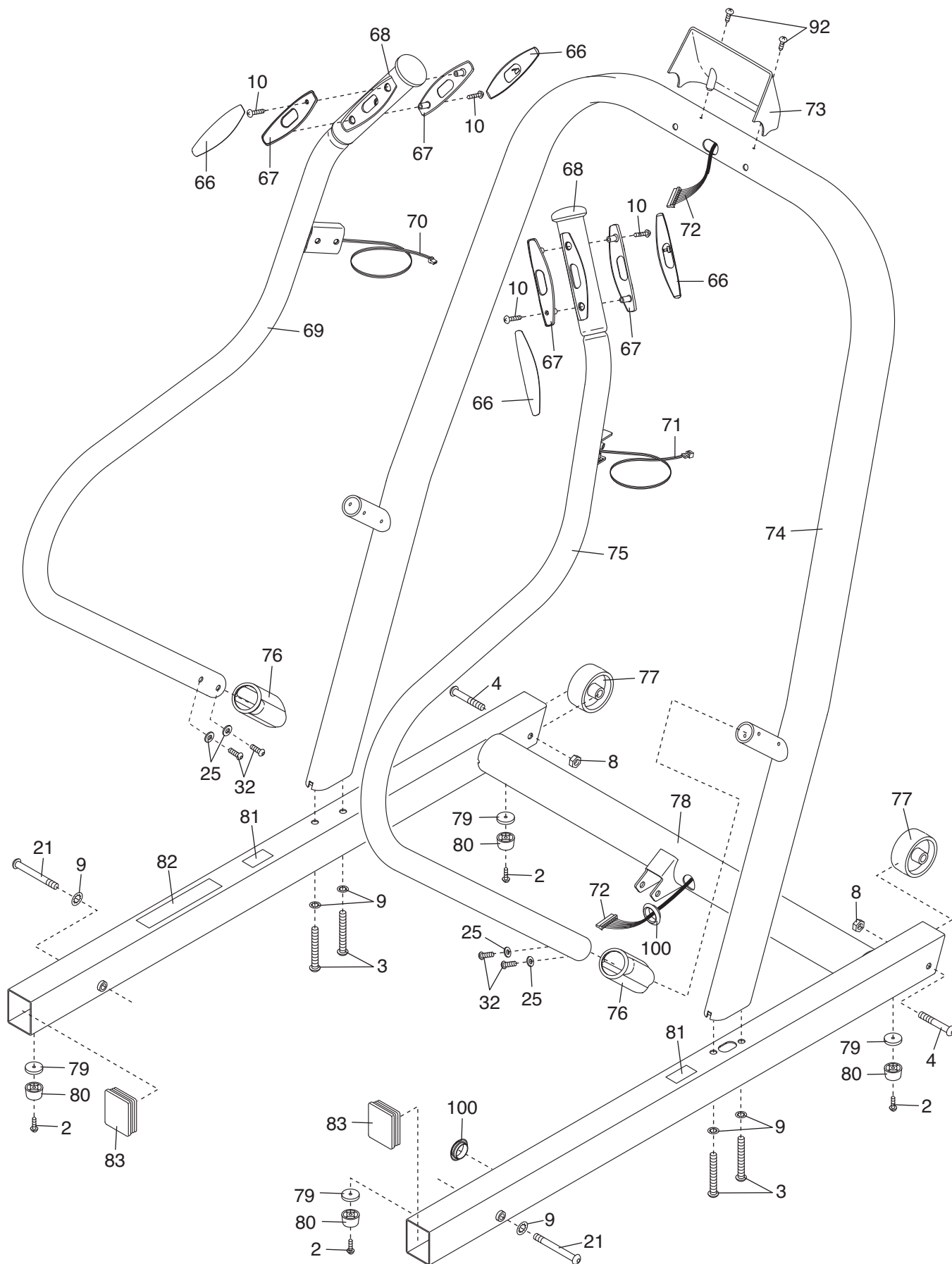

EXPLODED DRAWING D—Model No. NTL15008.1

R0709A

