

EXPLODED DRAWING A—Model No. NTL15909.2

R0310A

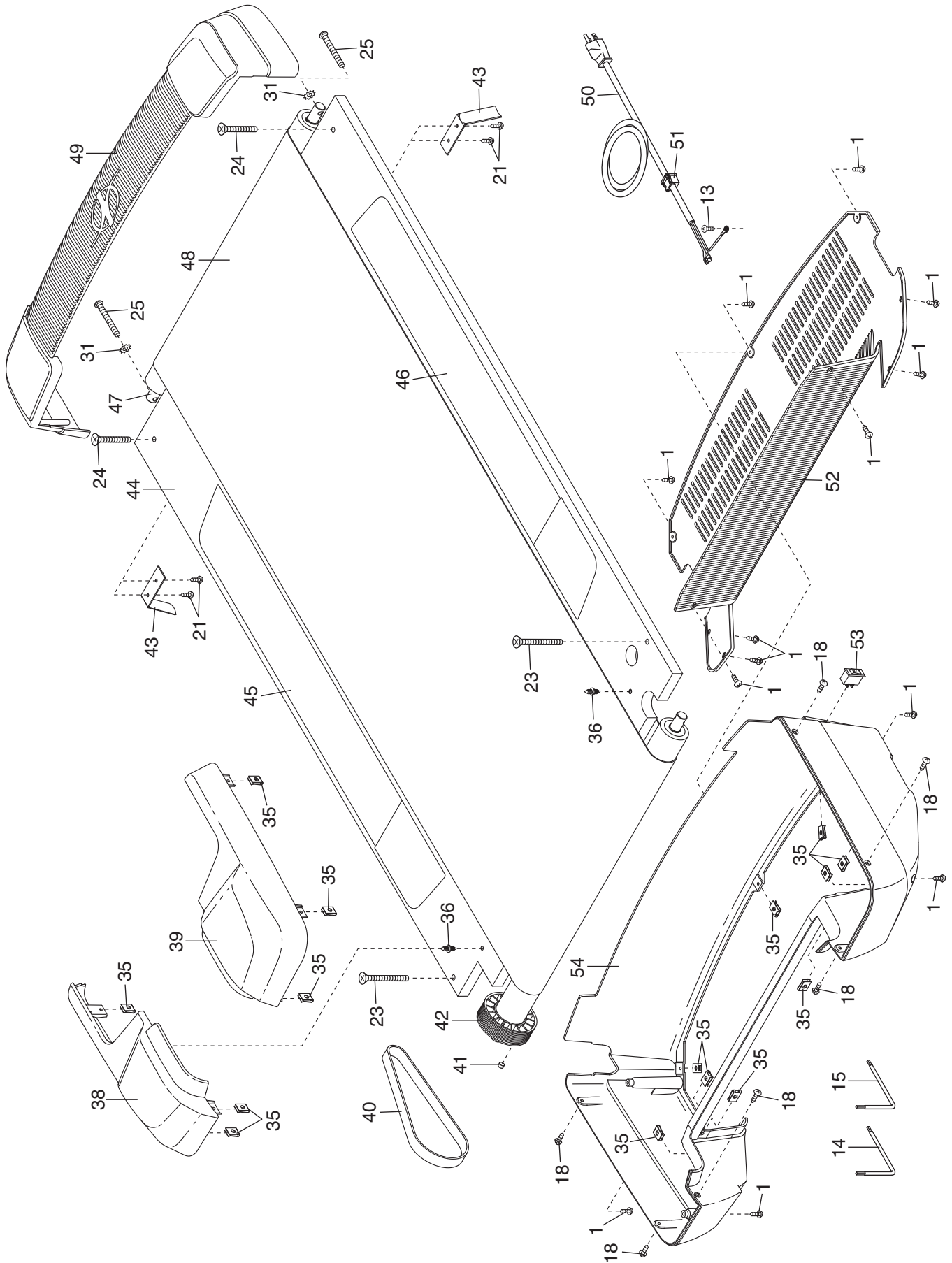

EXPLODED DRAWING B—Model No. NTL15909.2

R0310A

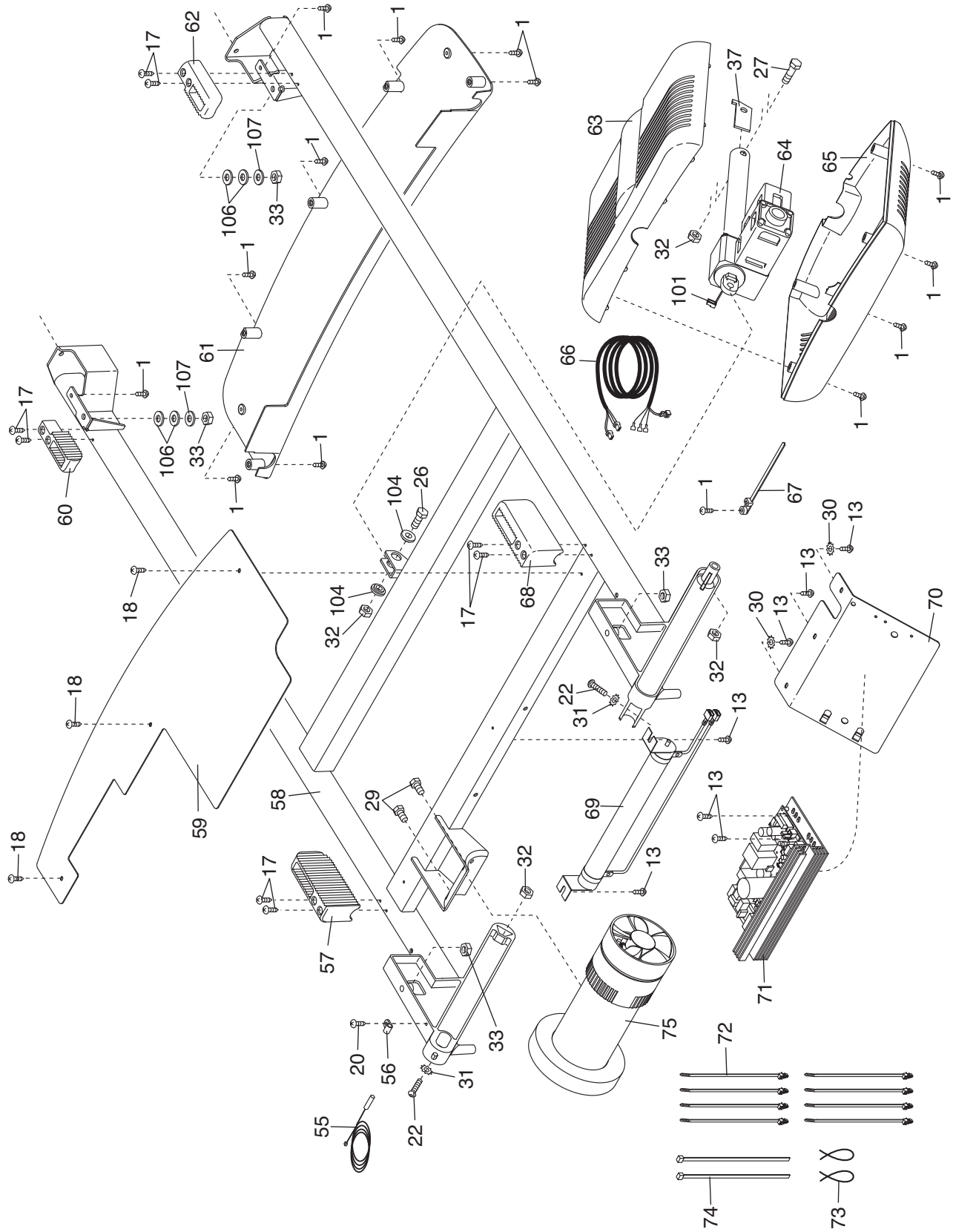

EXPLODED DRAWING C—Model No. NTL15909.2

R0310A

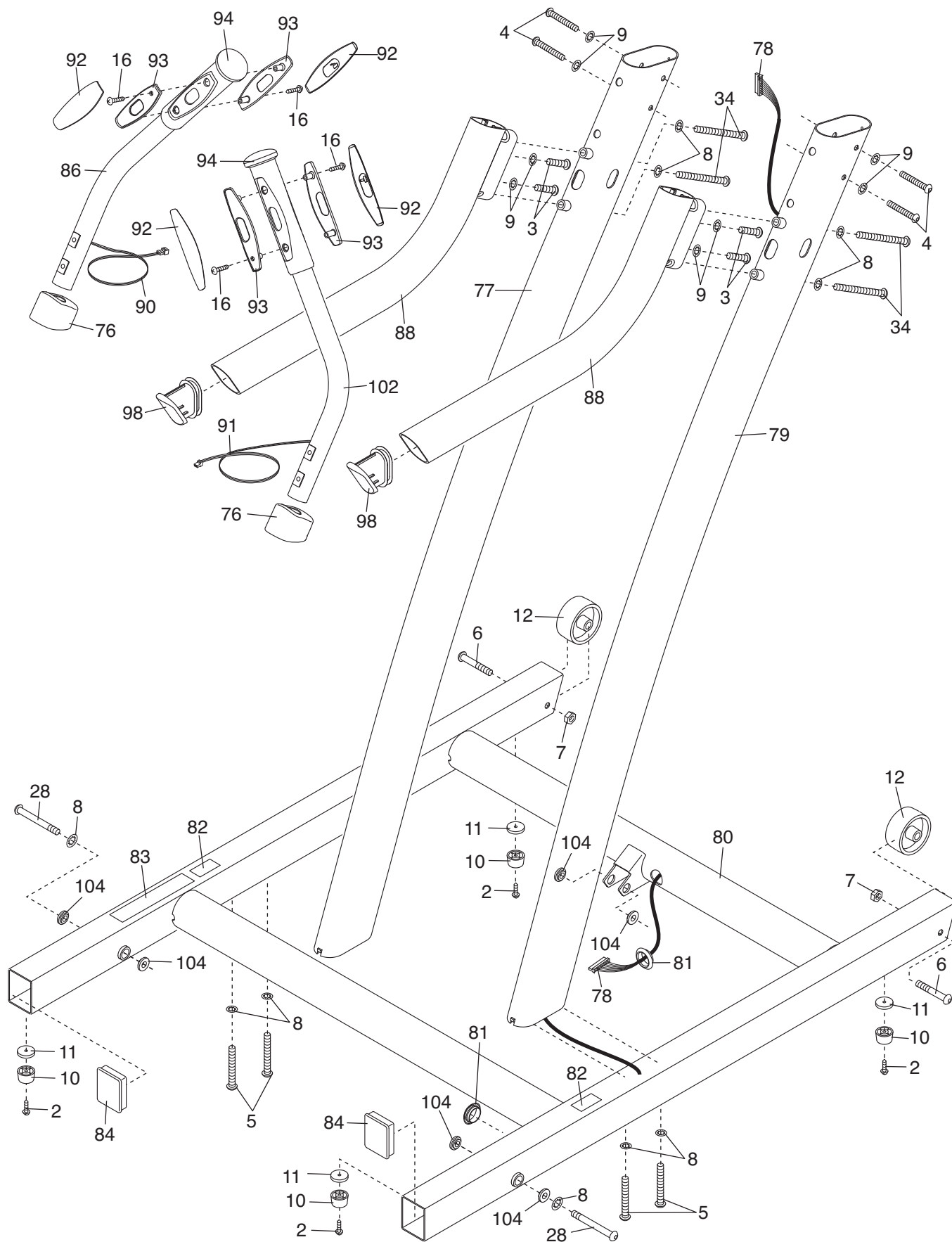

EXPLODED DRAWING D—Model No. NTL15909.2

R0310A

