

EXPLODED DRAWING A—Model No. NTL20909.2

R0210A

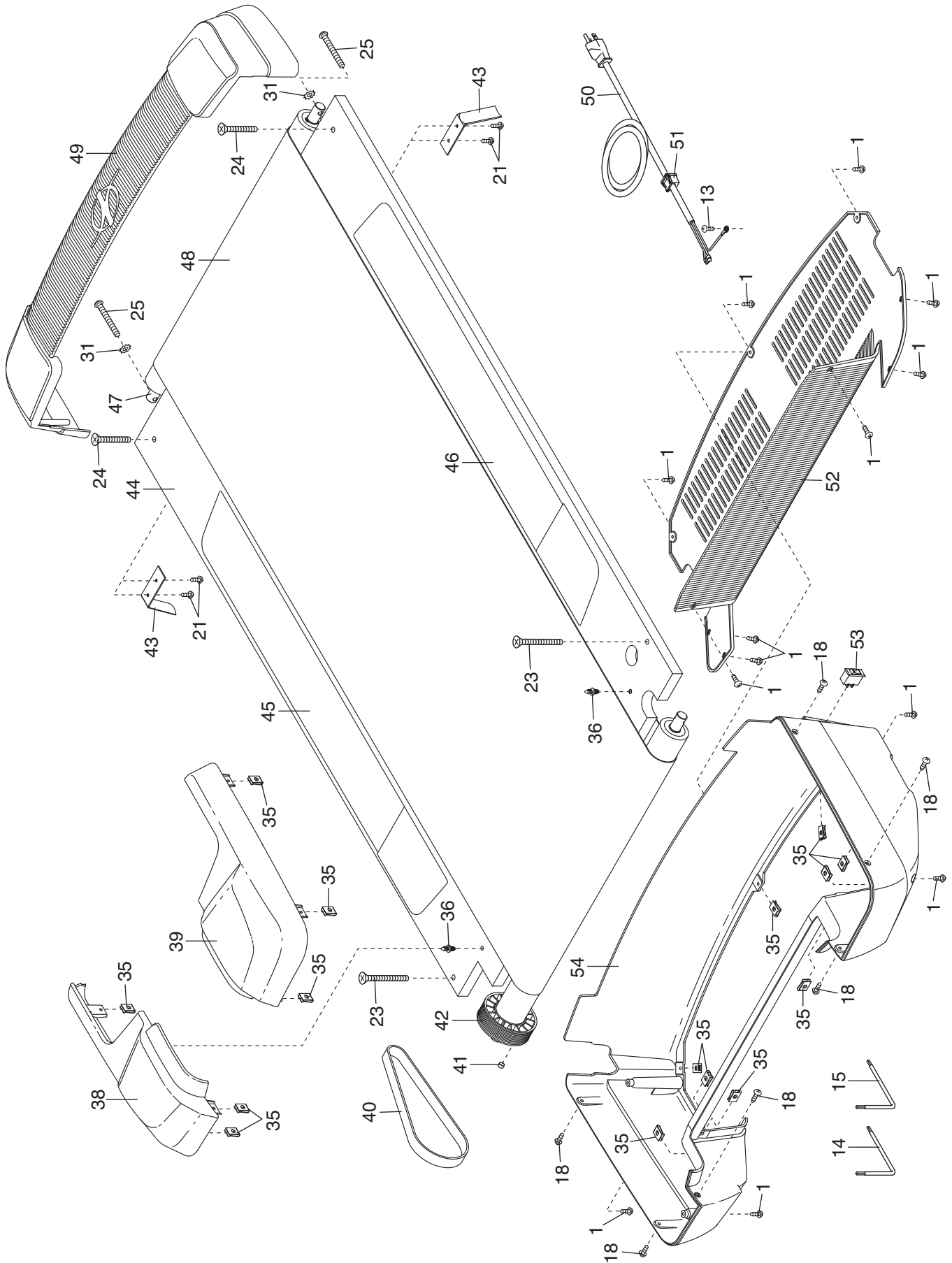

EXPLODED DRAWING B—Model No. NTL20909.2

R0210A

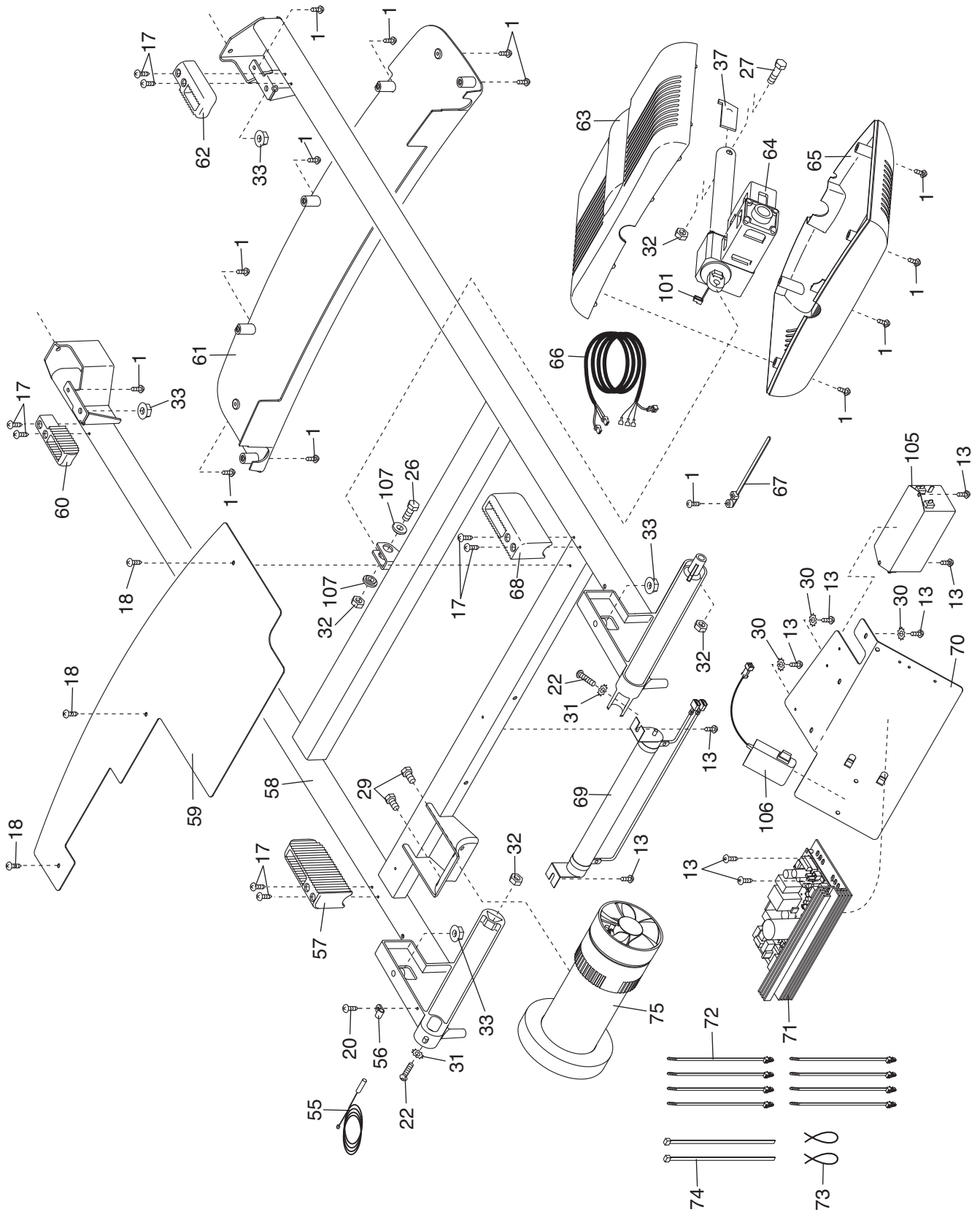

EXPLODED DRAWING C—Model No. NTL20909.2

R0210A

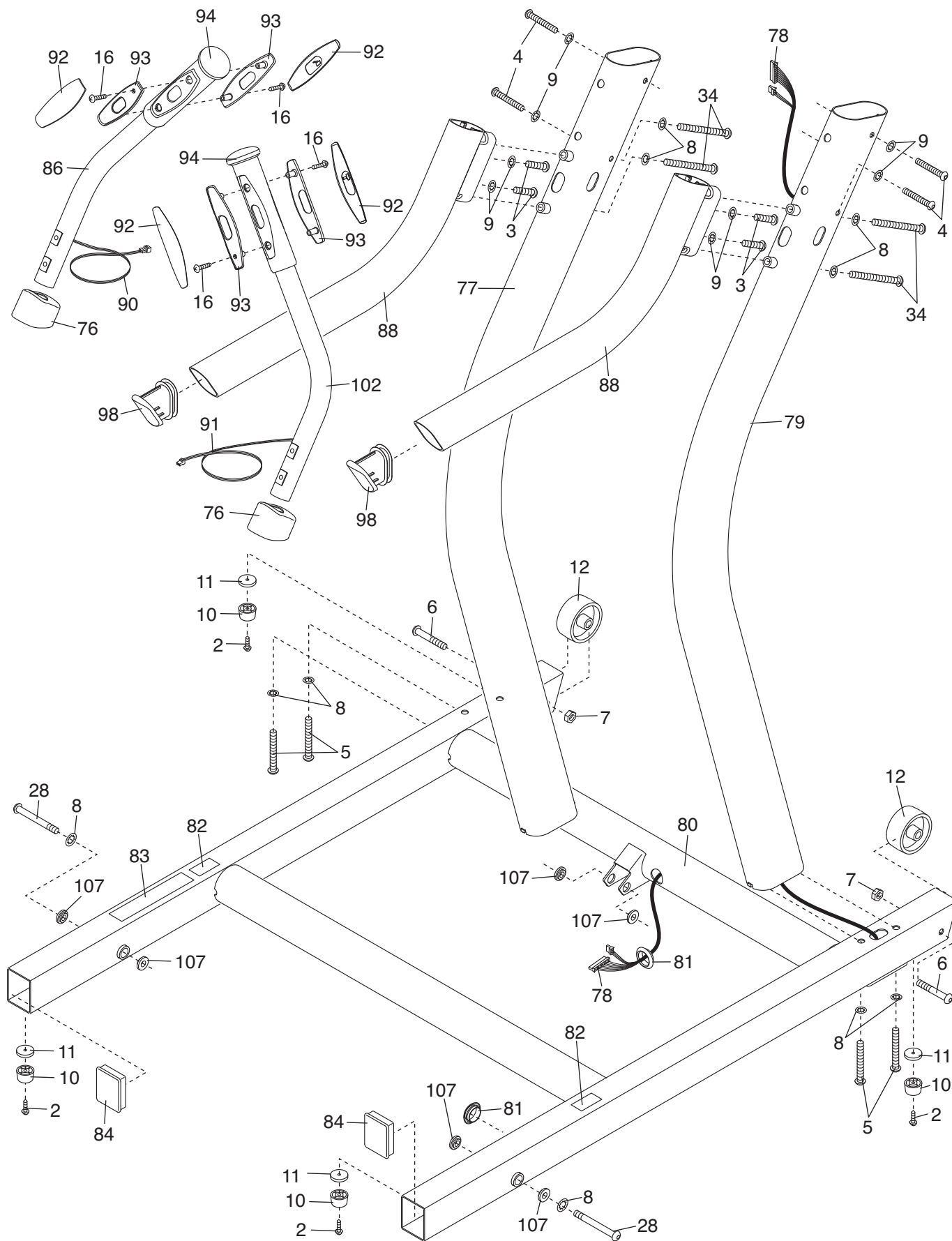

EXPLODED DRAWING D—Model No. NTL20909.2

R0210A

