

EXPLODED DRAWING A

Model No. NTL20909.5 R0811A

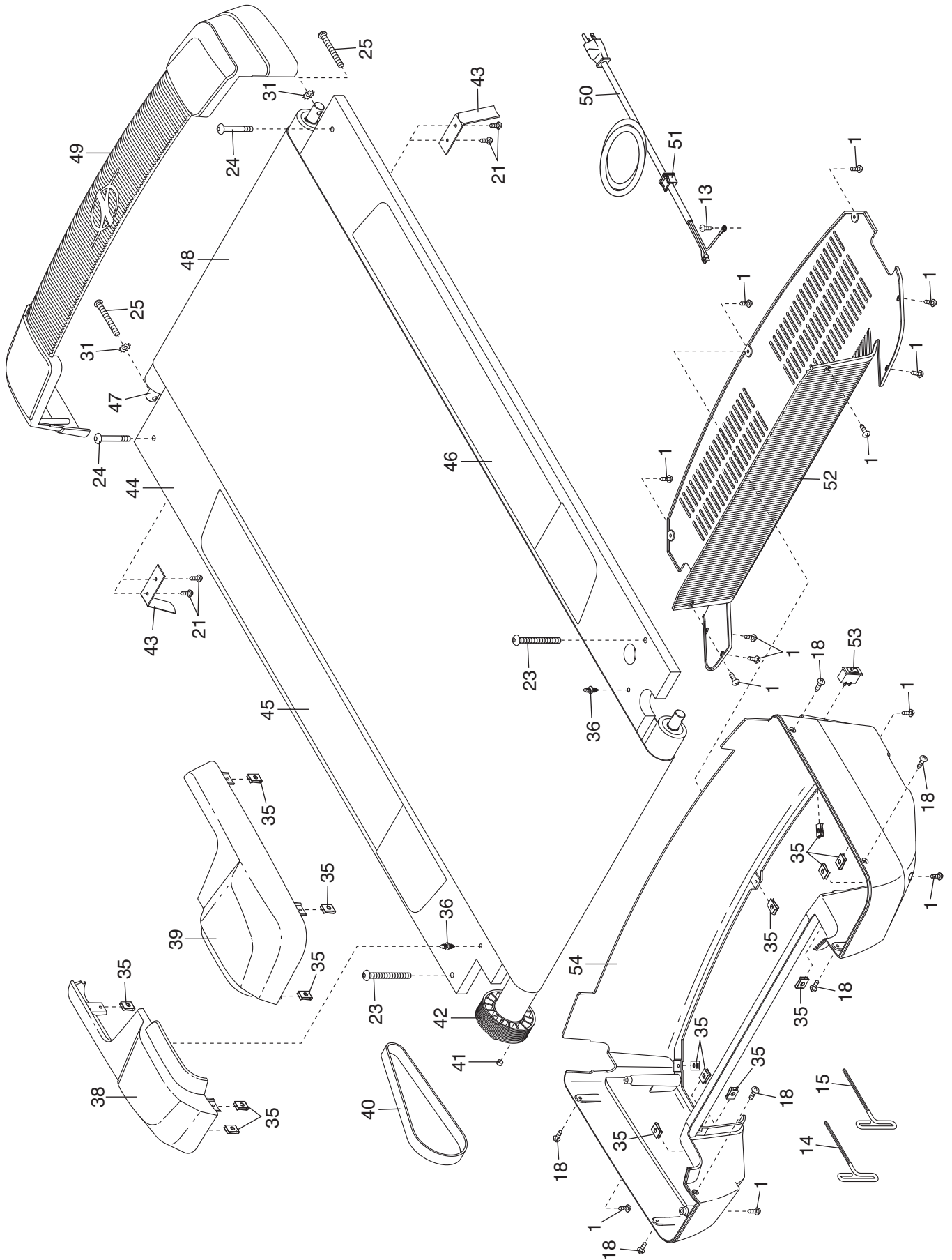

EXPLODED DRAWING B

Model No. NTL20909.5 R0811A

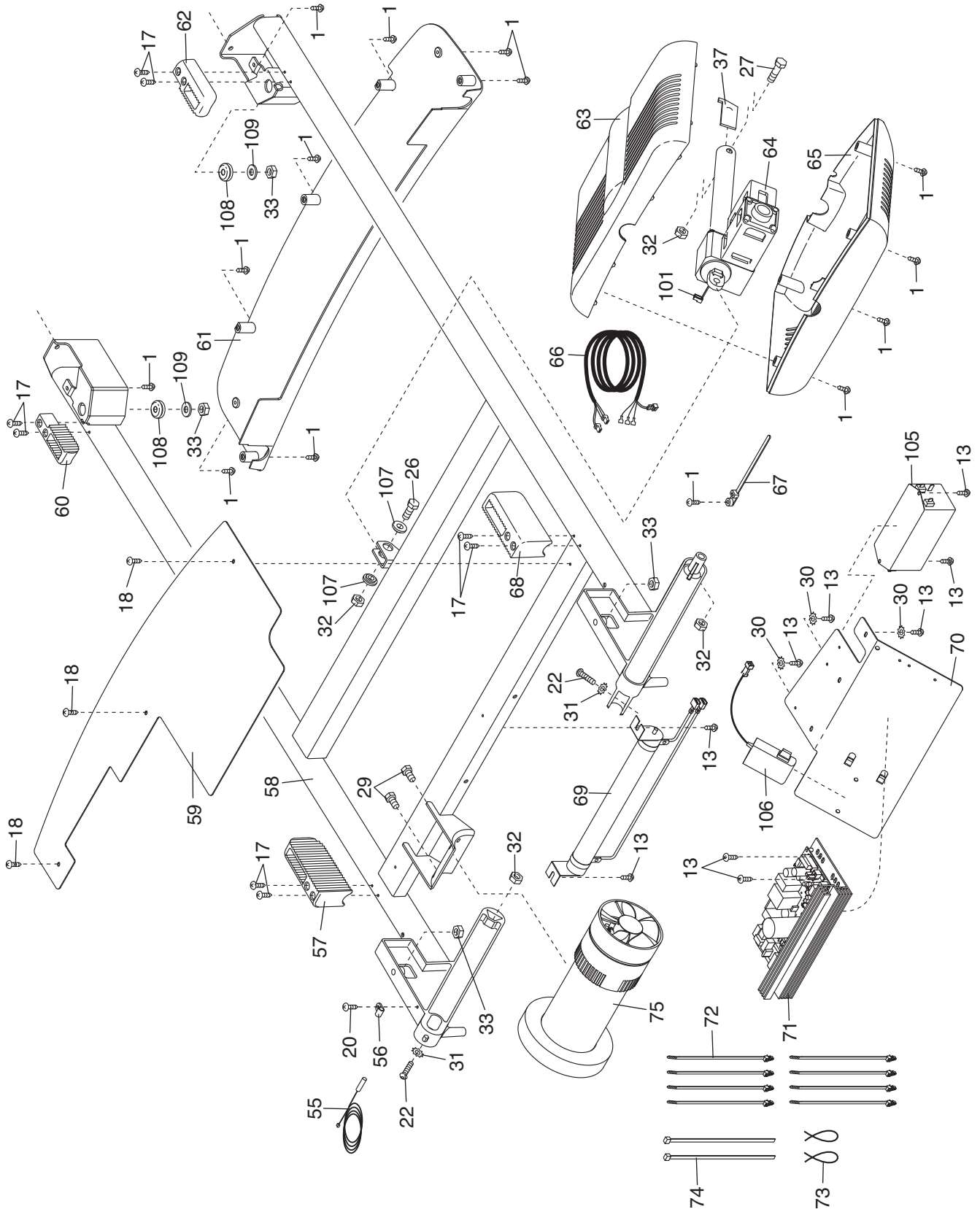

EXPLODED DRAWING C

Model No. NTL20909.5 R0811A

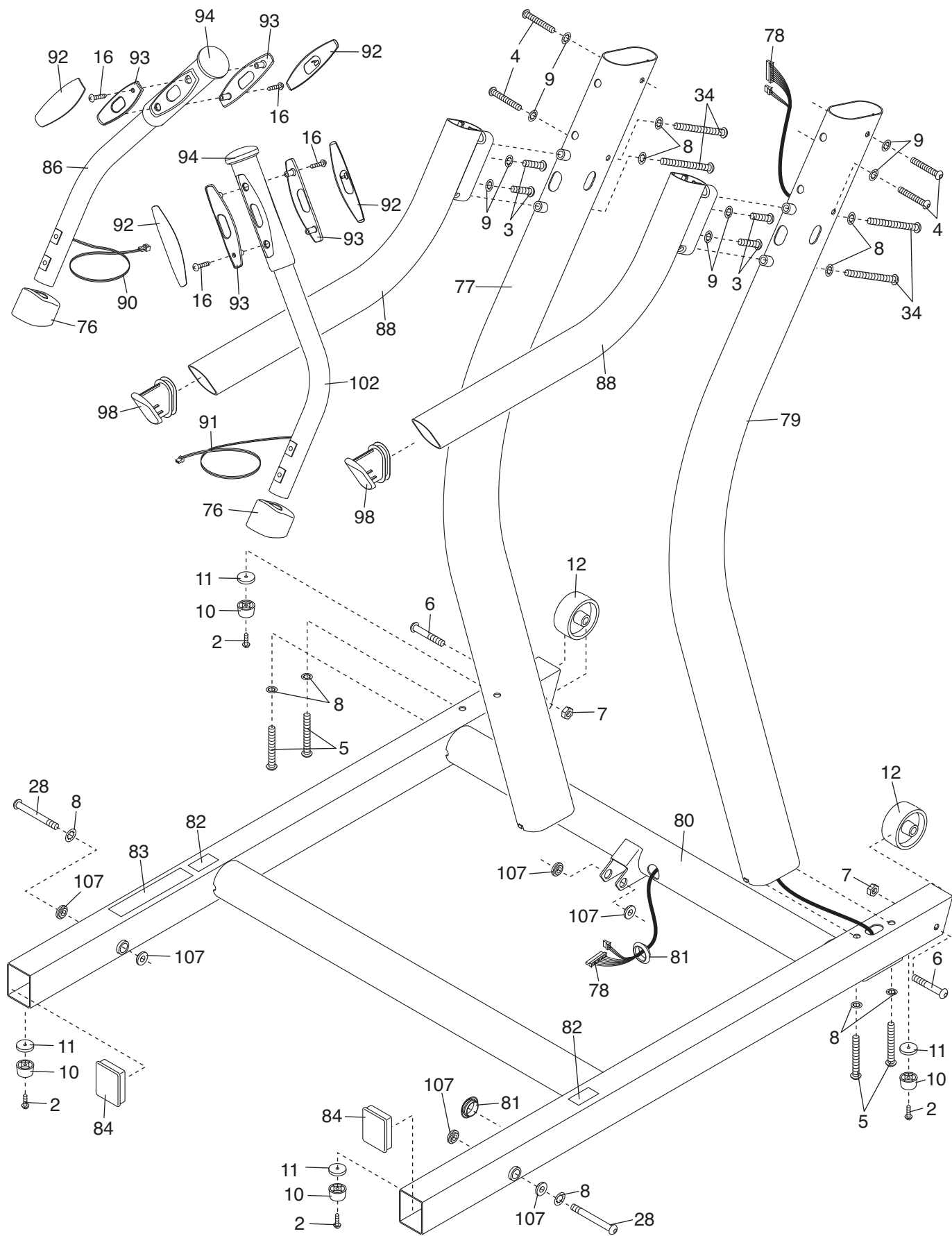

EXPLODED DRAWING D

Model No. NTL20909.5 R0811A

