

EXPLODED DRAWING A—Model No. 831.24822.0

R0910A

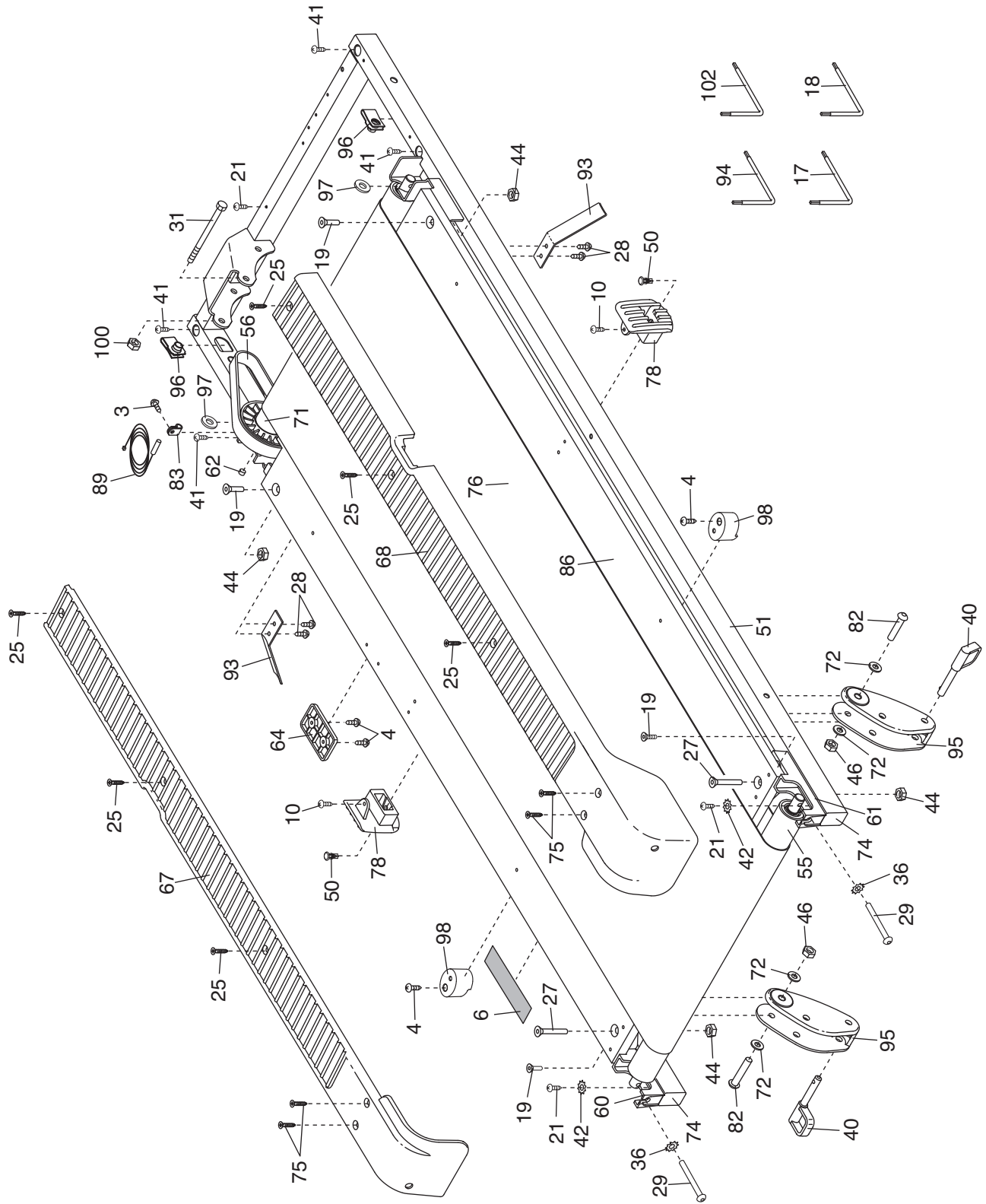

EXPLODED DRAWING B—Model No. 831.24822.0

R0910A

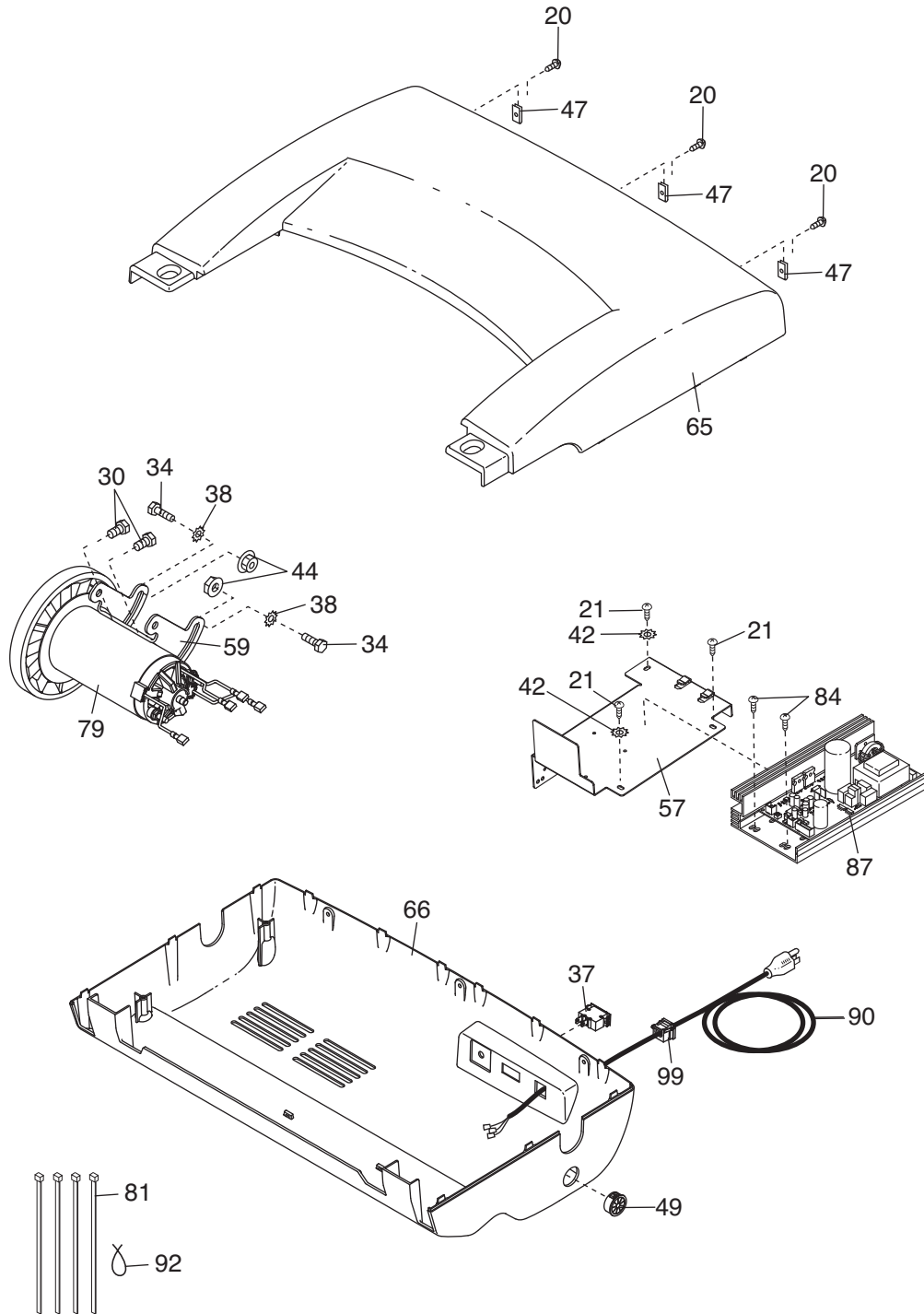

EXPLODED DRAWING C—Model No. 831.24822.0

R0910A

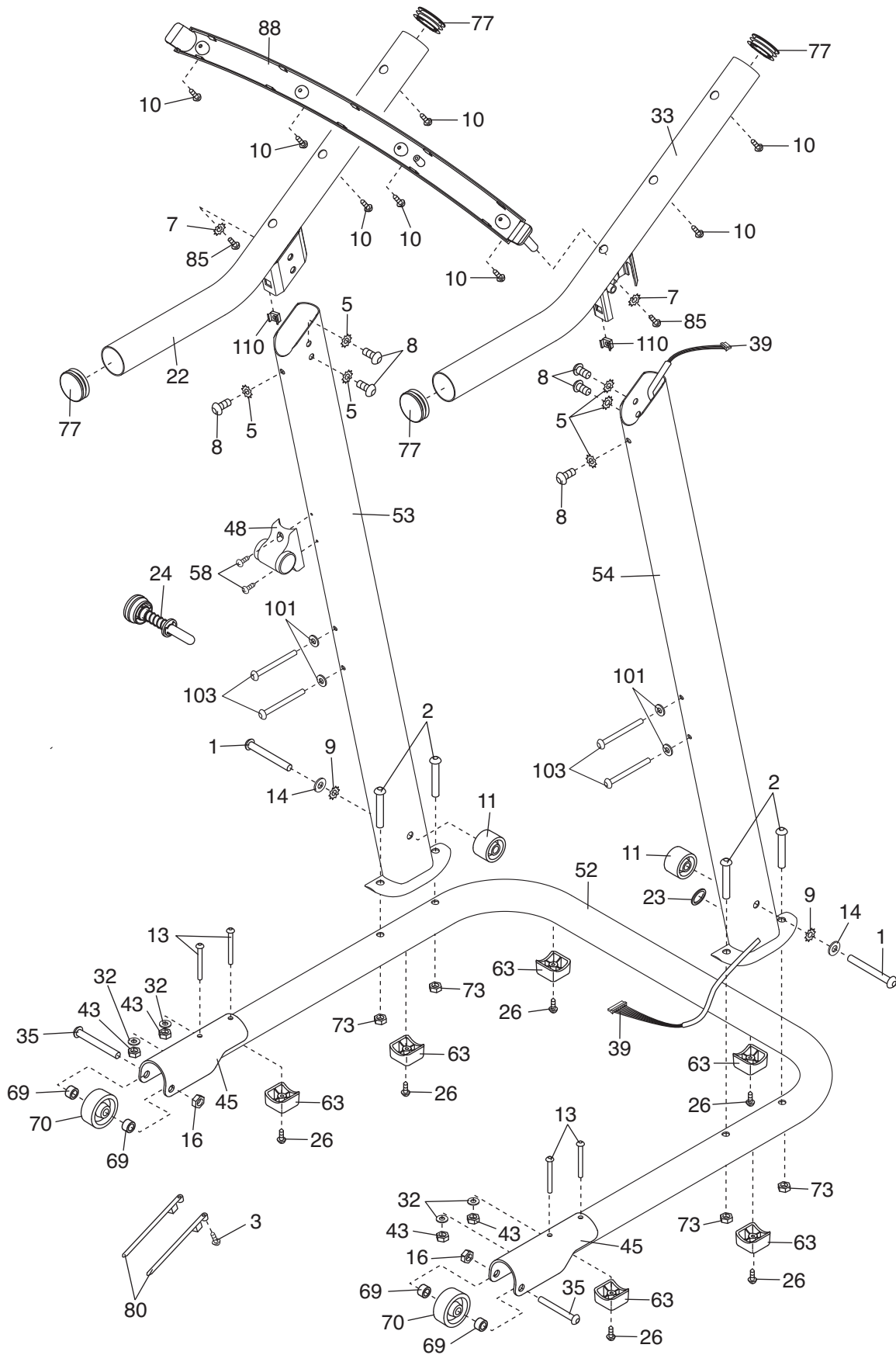

EXPLODED DRAWING D—Model No. 831.24822.0

R0910A

