

EXPLODED DRAWING A—Model No. 831.24824.2

R0808A

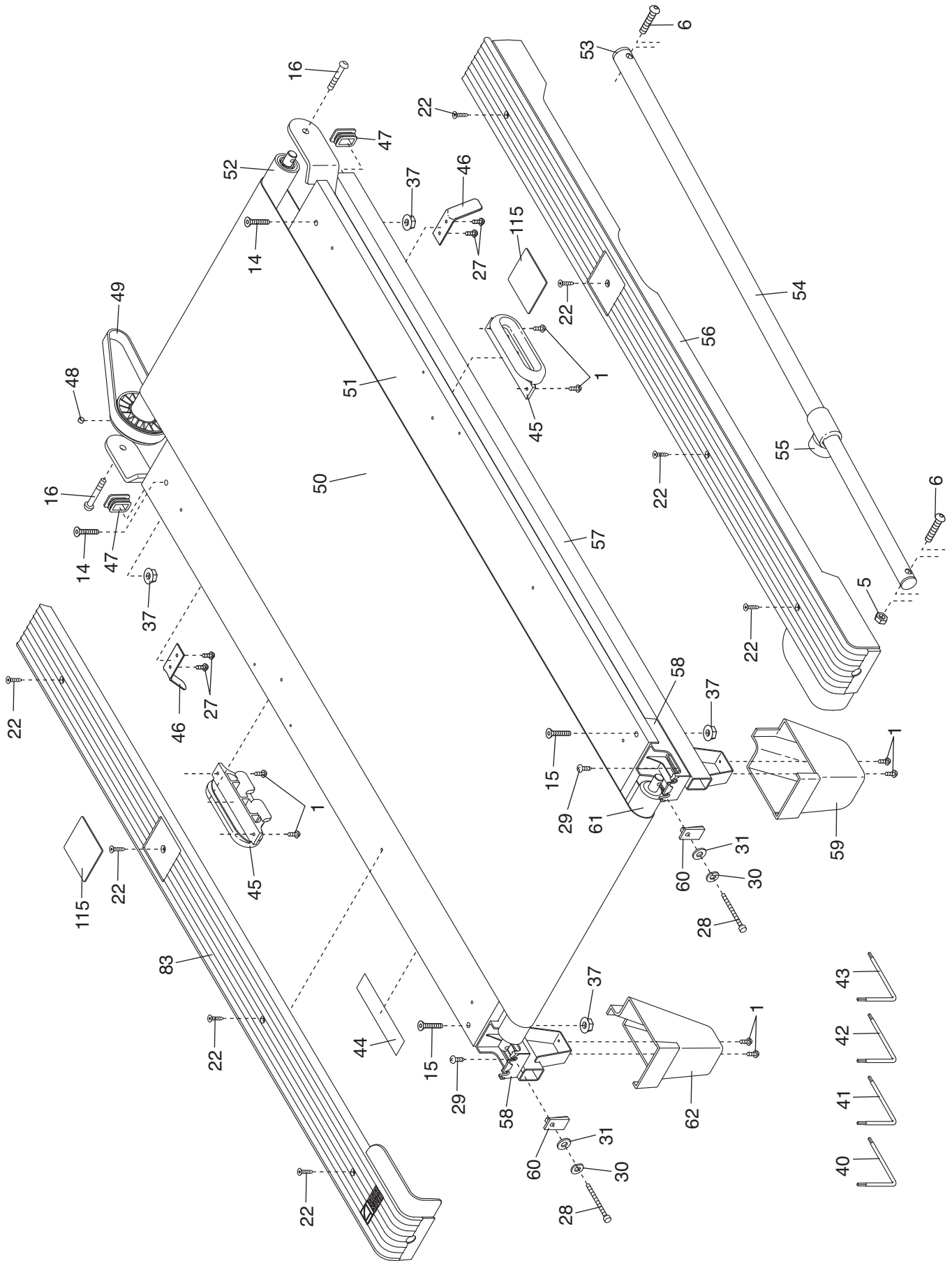

EXPLODED DRAWING B—Model No. 831.24824.2

R0808A

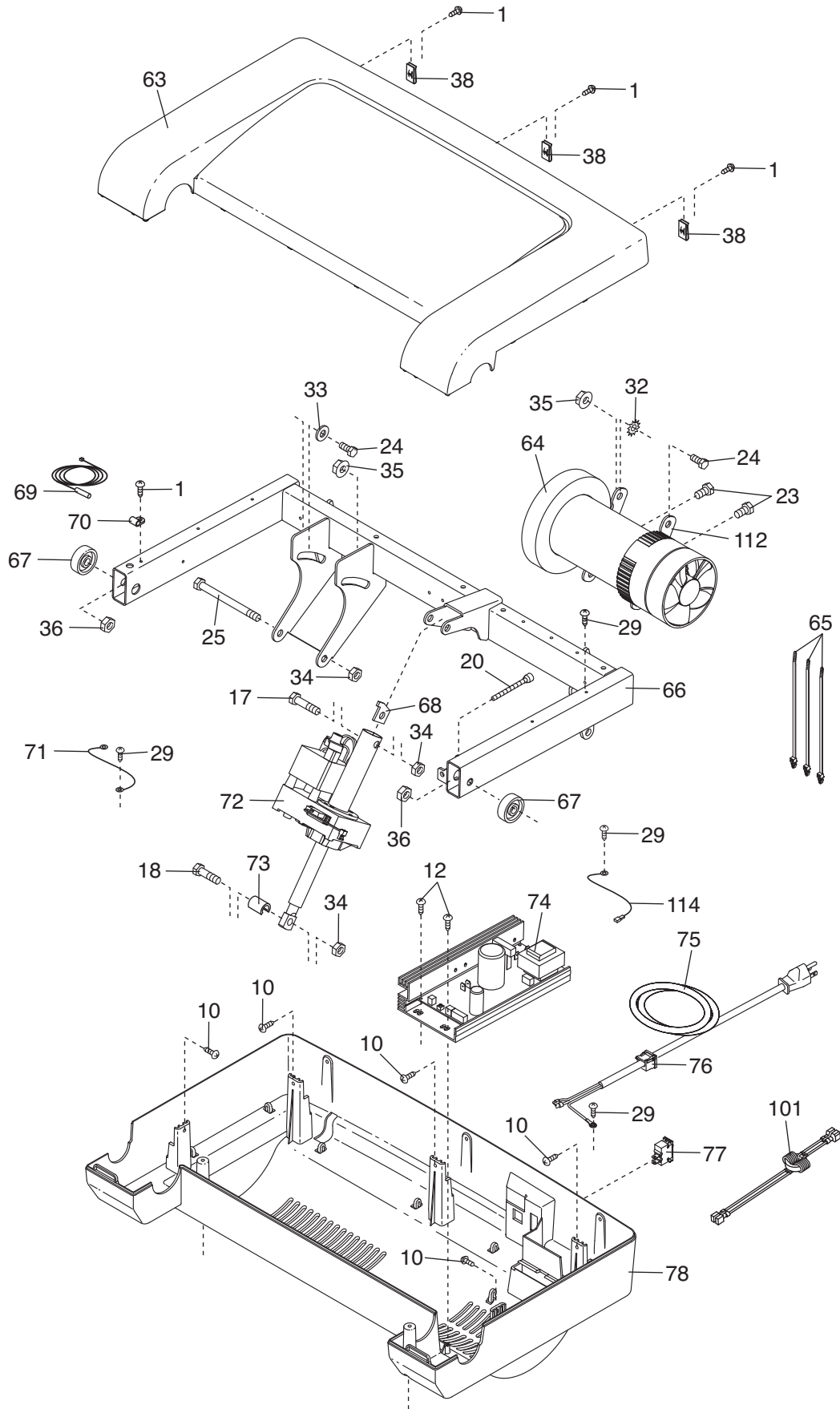

EXPLODED DRAWING C—Model No. 831.24824.2

R0808A

