

EXPLODED DRAWING A—Model No. 831.24824.4

R0109A

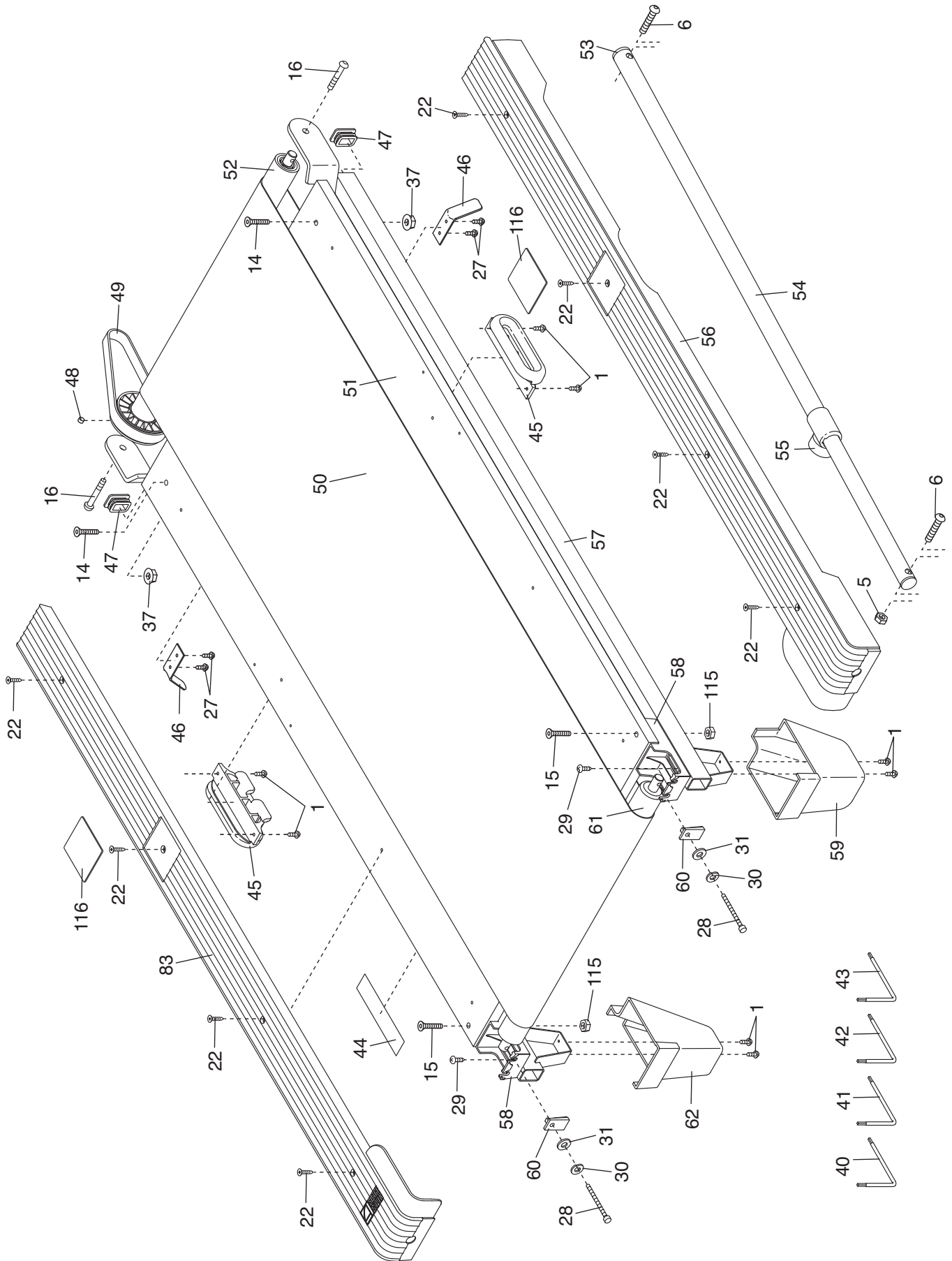

EXPLODED DRAWING B—Model No. 831.24824.4

R0109A

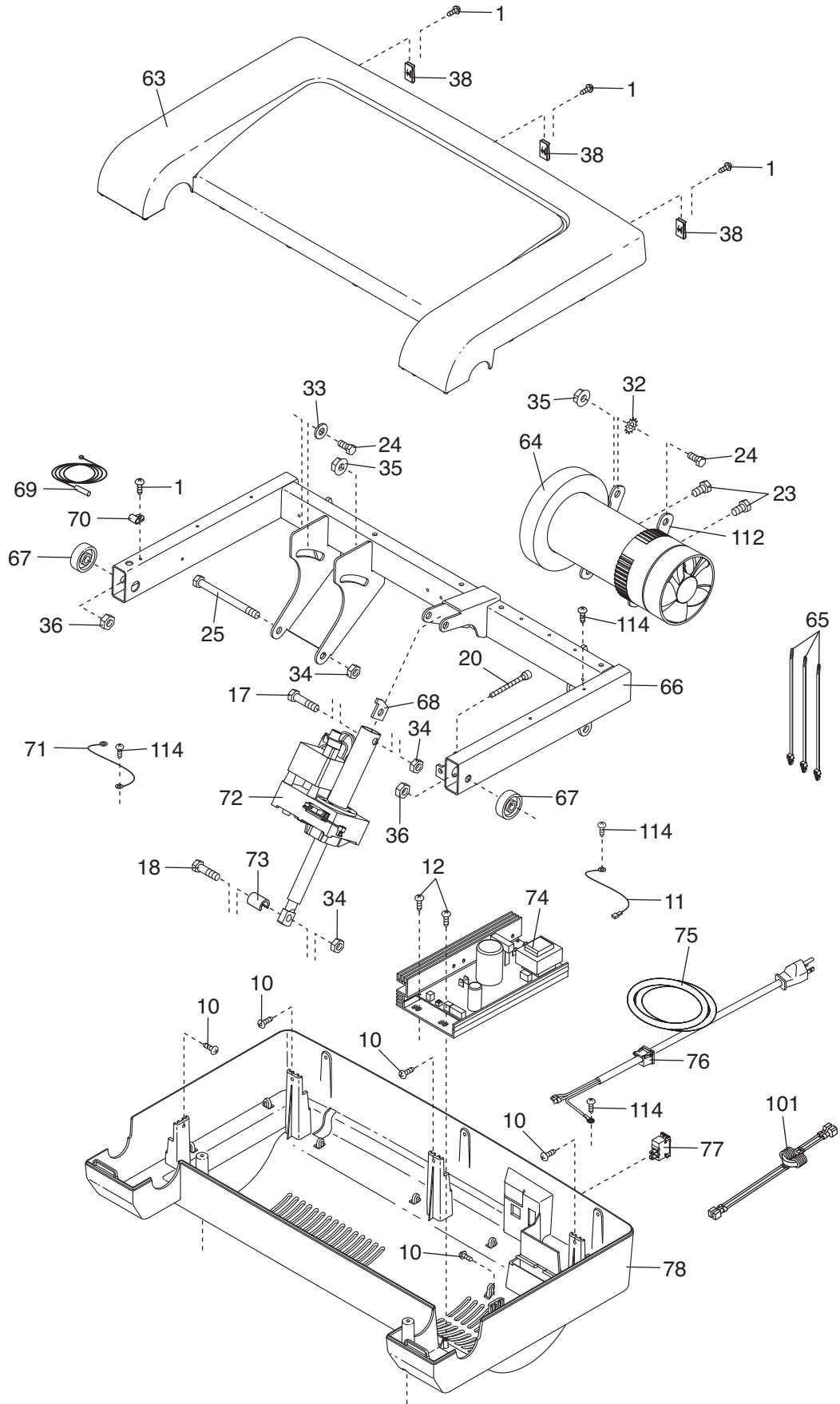

EXPLODED DRAWING C—Model No. 831.24824.4

R0109A

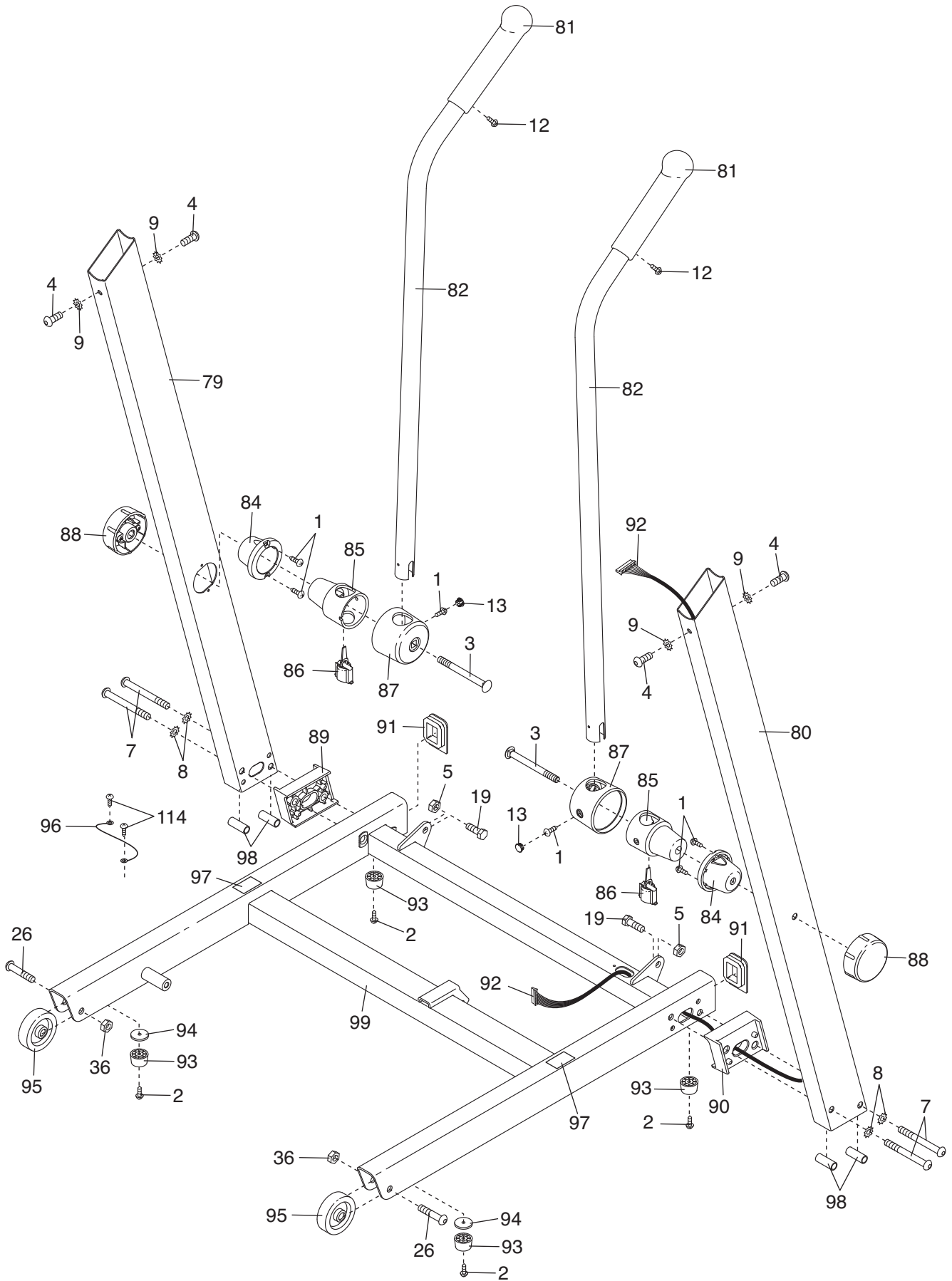

EXPLODED DRAWING D—Model No. 831.24824.4

R0109A

