

EXPLODED DRAWING A—Model No. 831.24824.6

R0809A

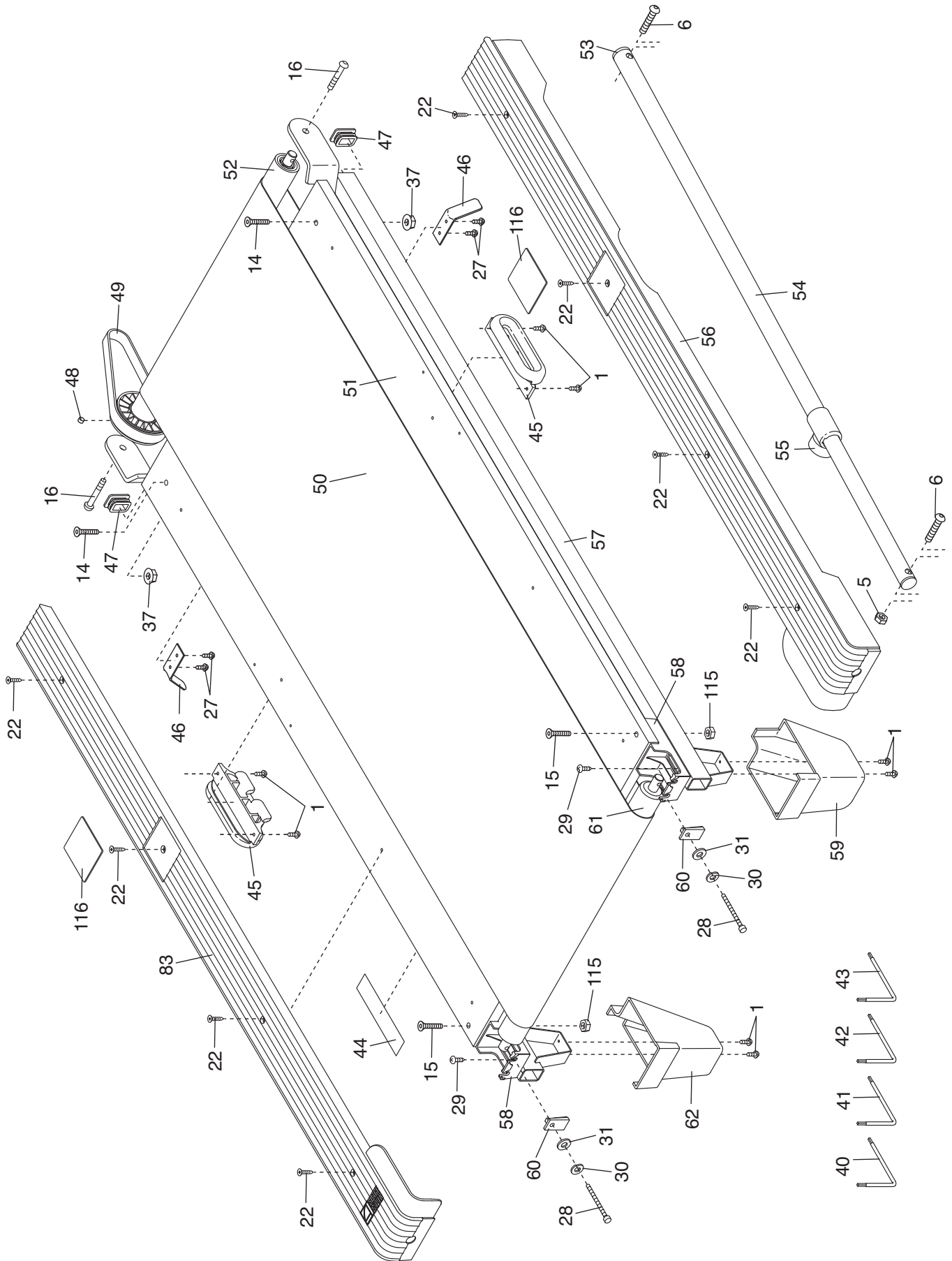

EXPLODED DRAWING B—Model No. 831.24824.6

R0809A

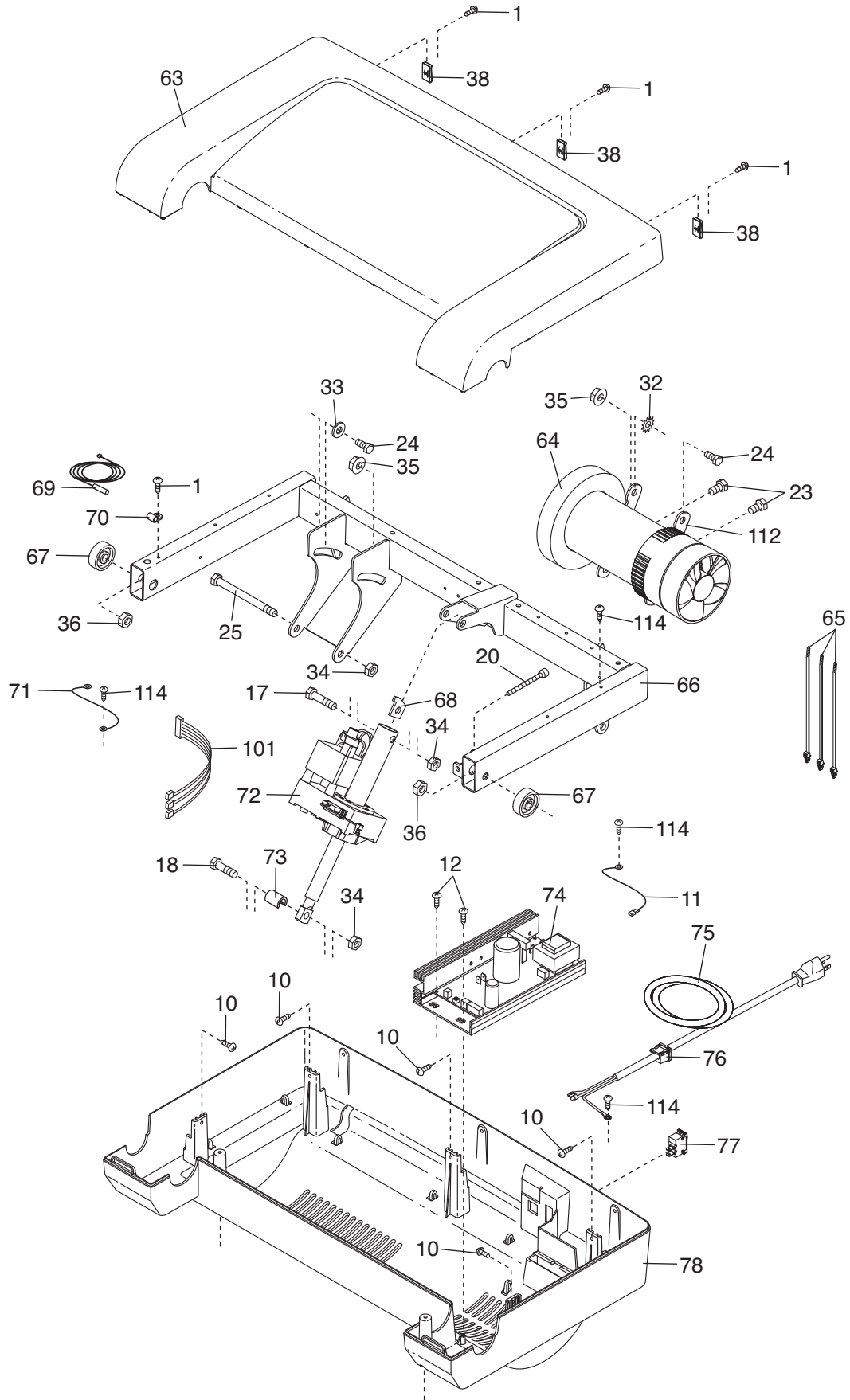

EXPLODED DRAWING C—Model No. 831.24824.6

R0809A

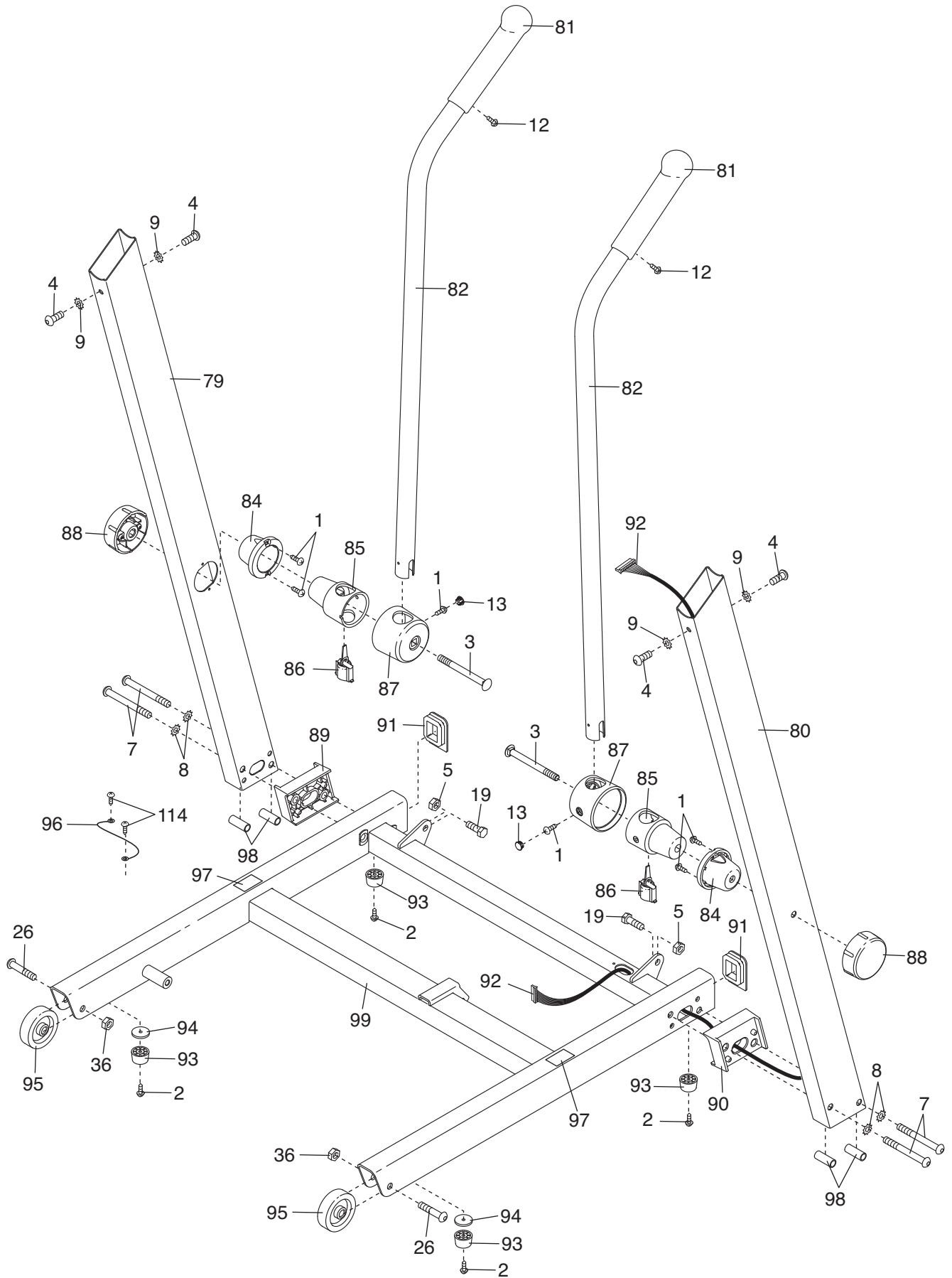

EXPLODED DRAWING D—Model No. 831.24824.6

R0809A

