

# EXPLODED DRAWING A

Model No. 831.24843.4 R1112A

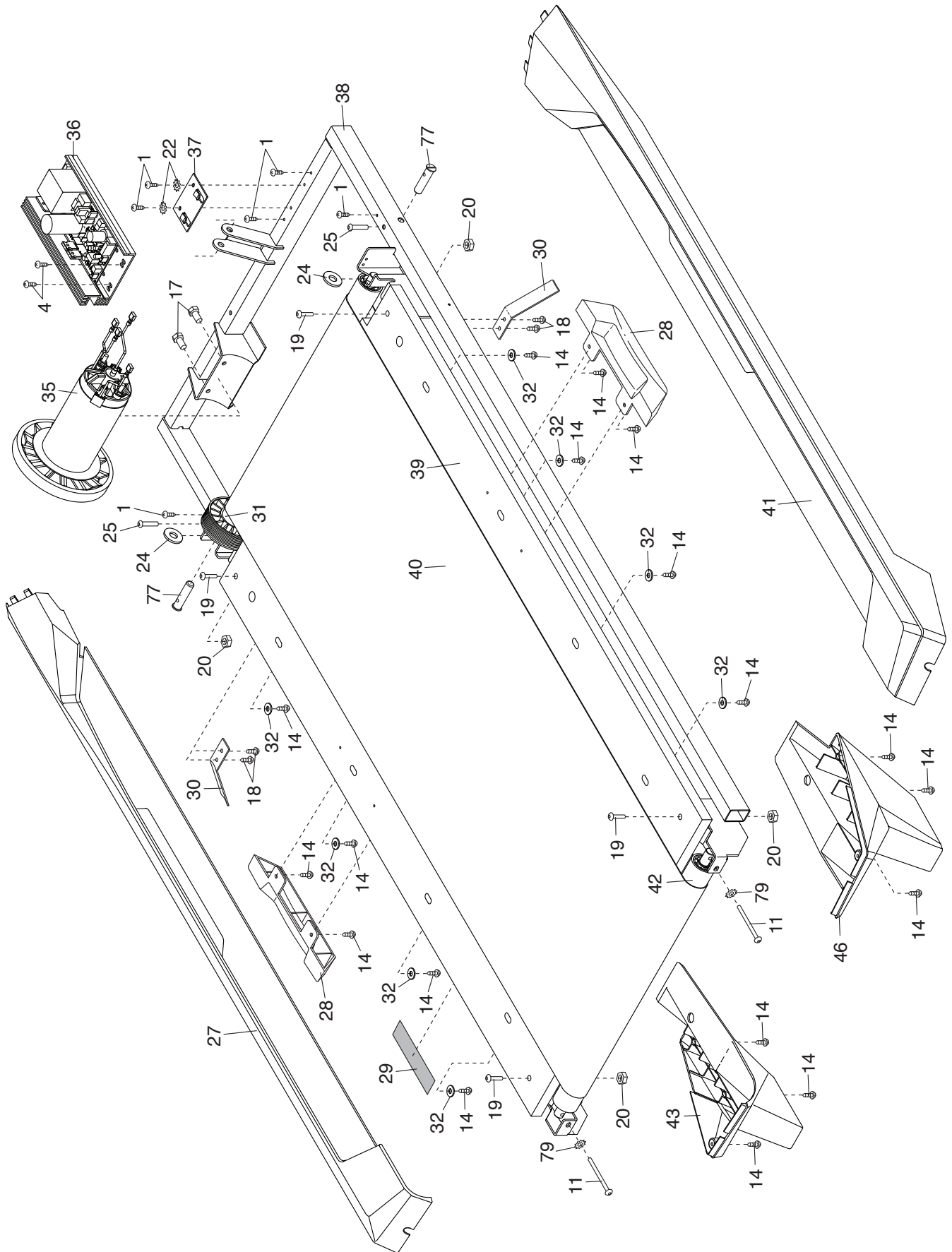

# EXPLODED DRAWING B

Model No. 831.24843.4 R1112A

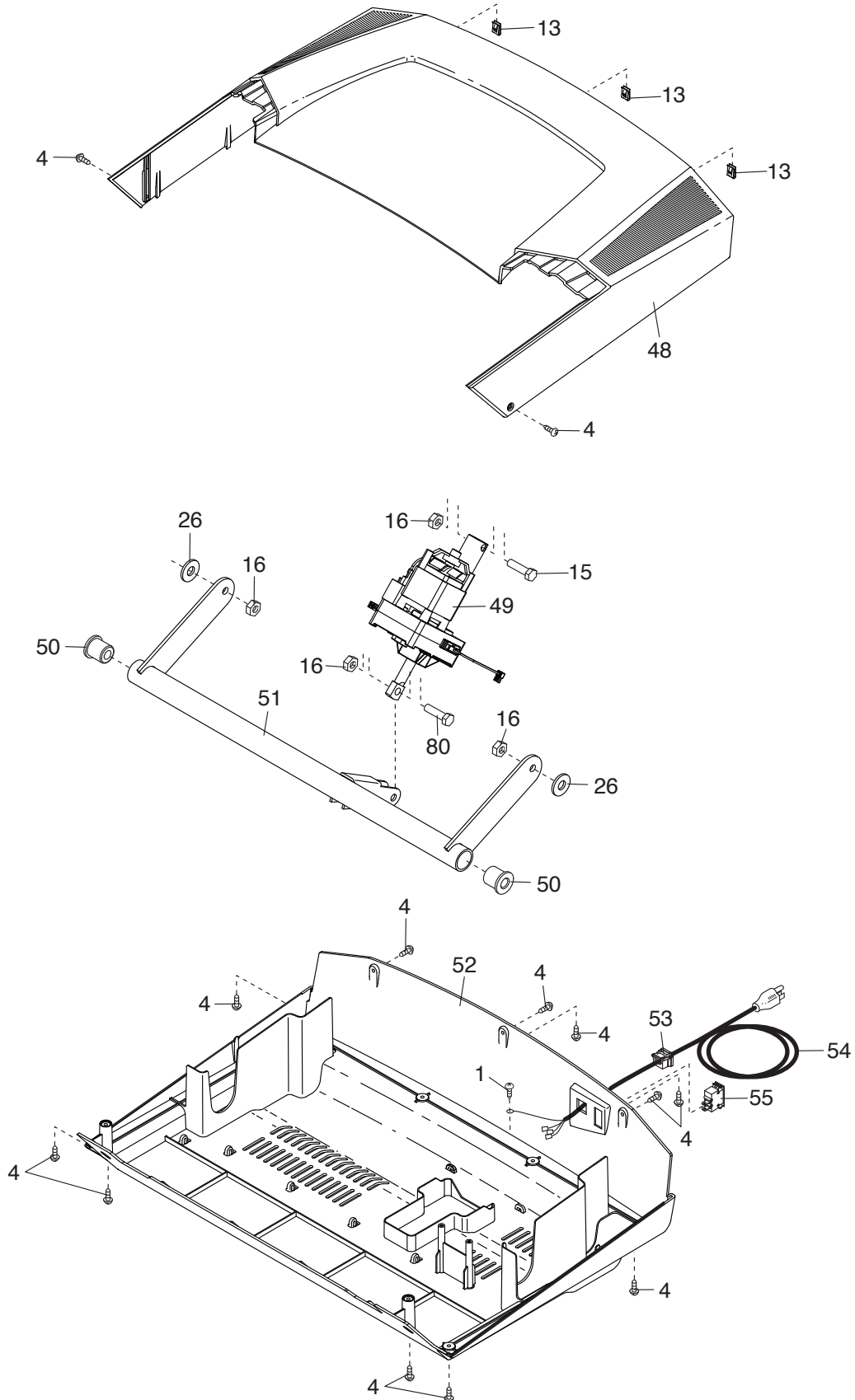

# EXPLODED DRAWING C

Model No. 831.24843.4 R1112A

