

EXPLODED DRAWING A

Model No. 831.24843.0 R0911A

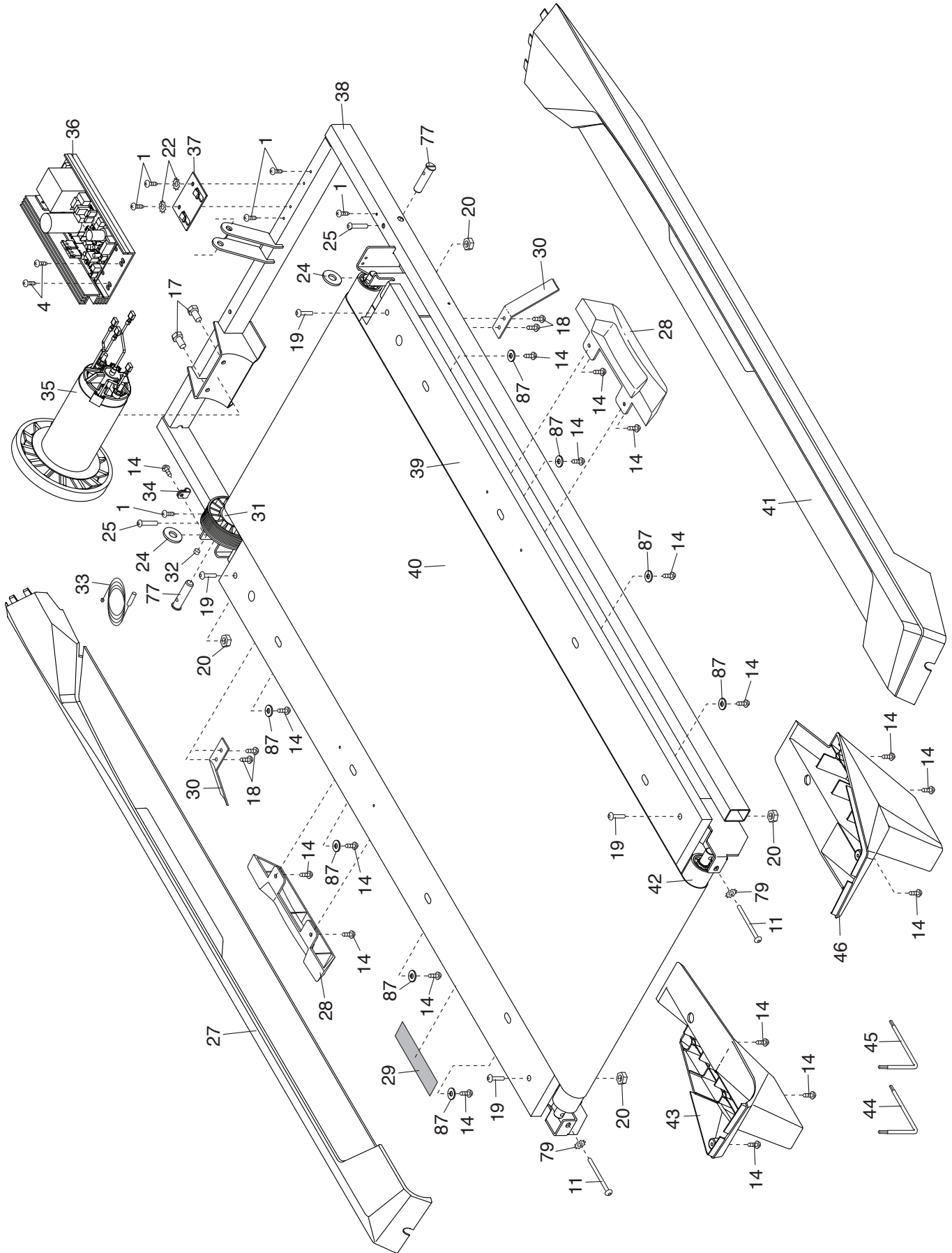

EXPLODED DRAWING B

Model No. 831.24843.0 R0911A

