

# EXPLODED DRAWING A

Model No. 831.24843.2 R0412A

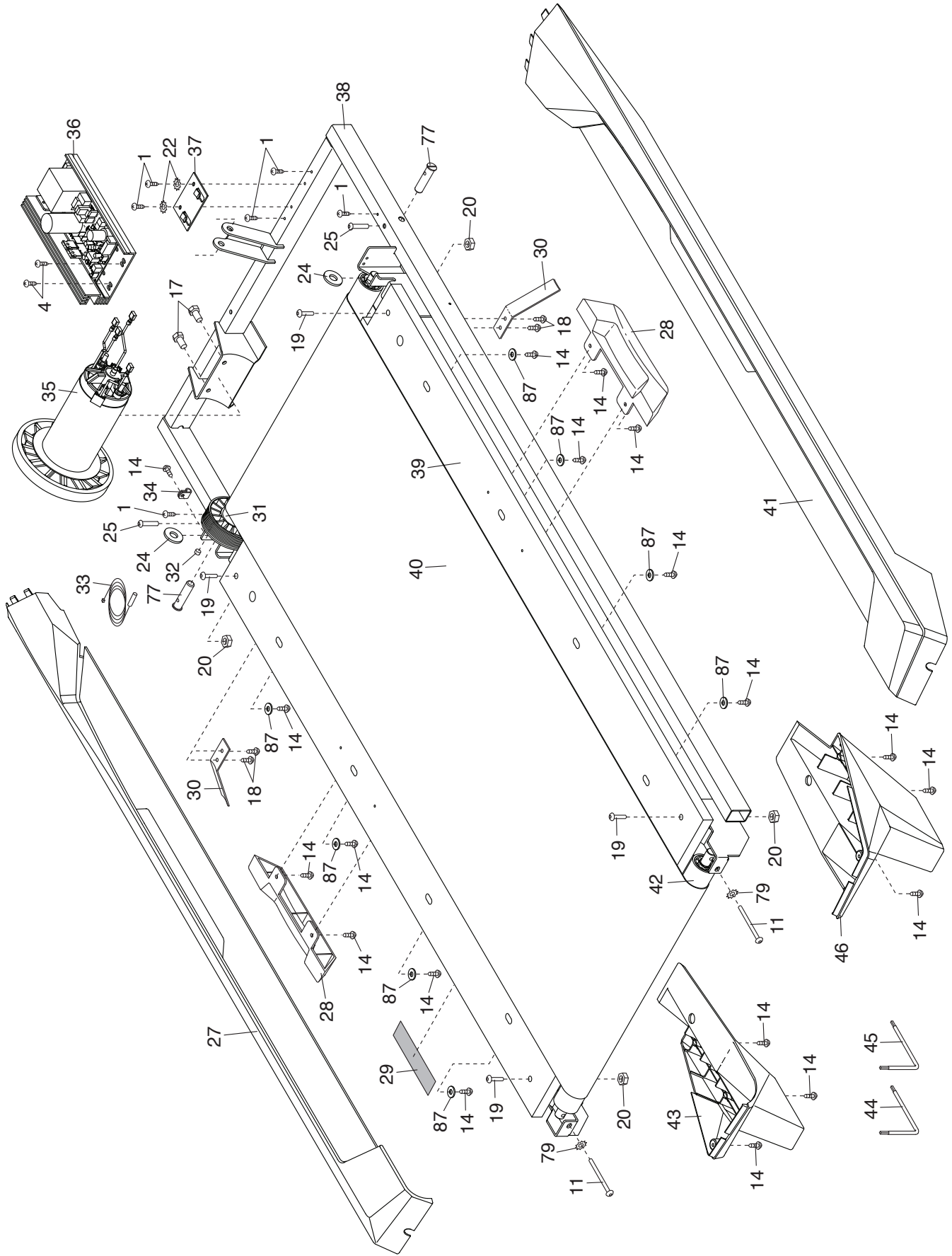

# EXPLODED DRAWING B

Model No. 831.24843.2 R0412A

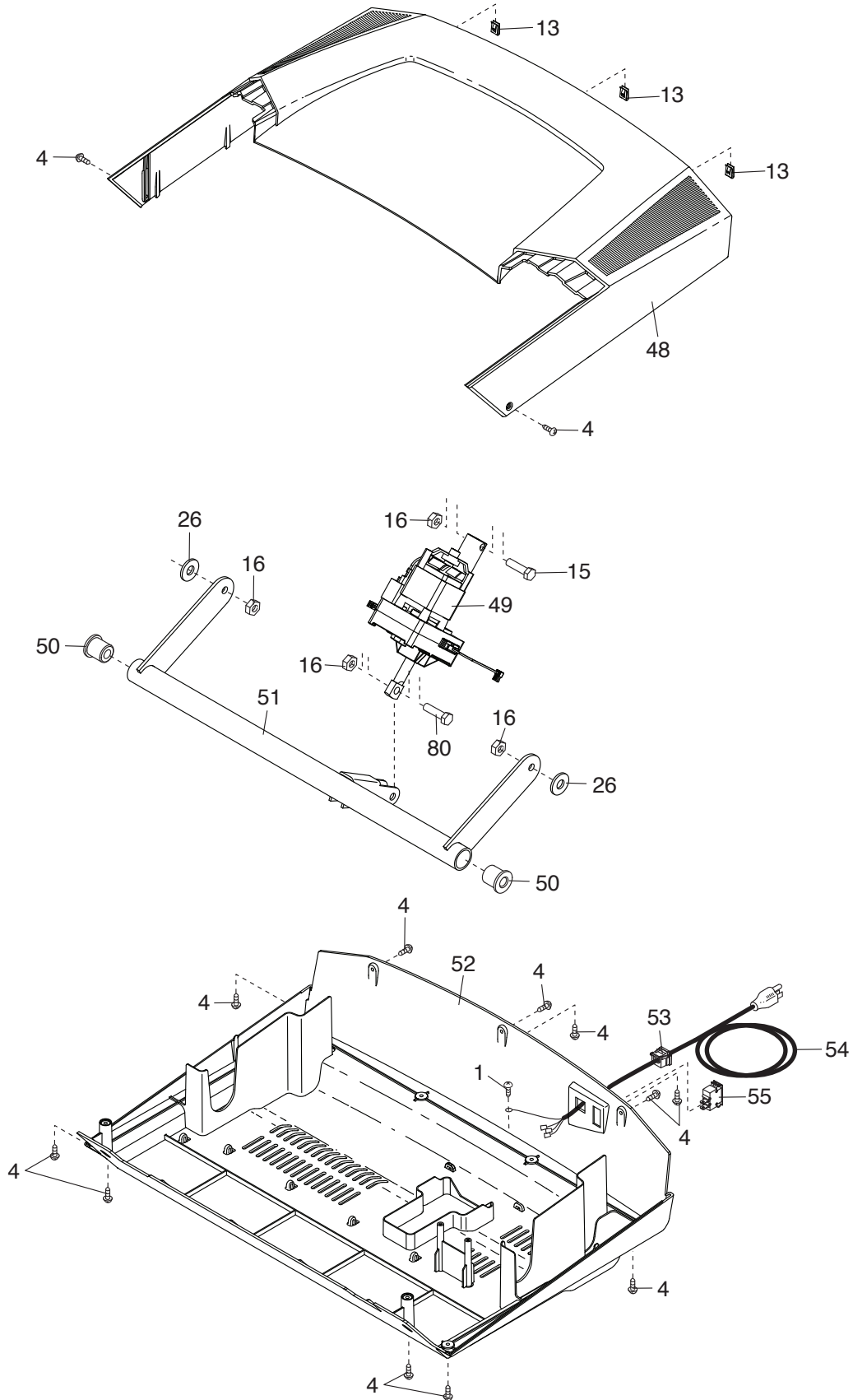

# EXPLODED DRAWING C

Model No. 831.24843.2 R0412A

