

EXPLODED DRAWING A

Model No. 831.24843.3 R0315A

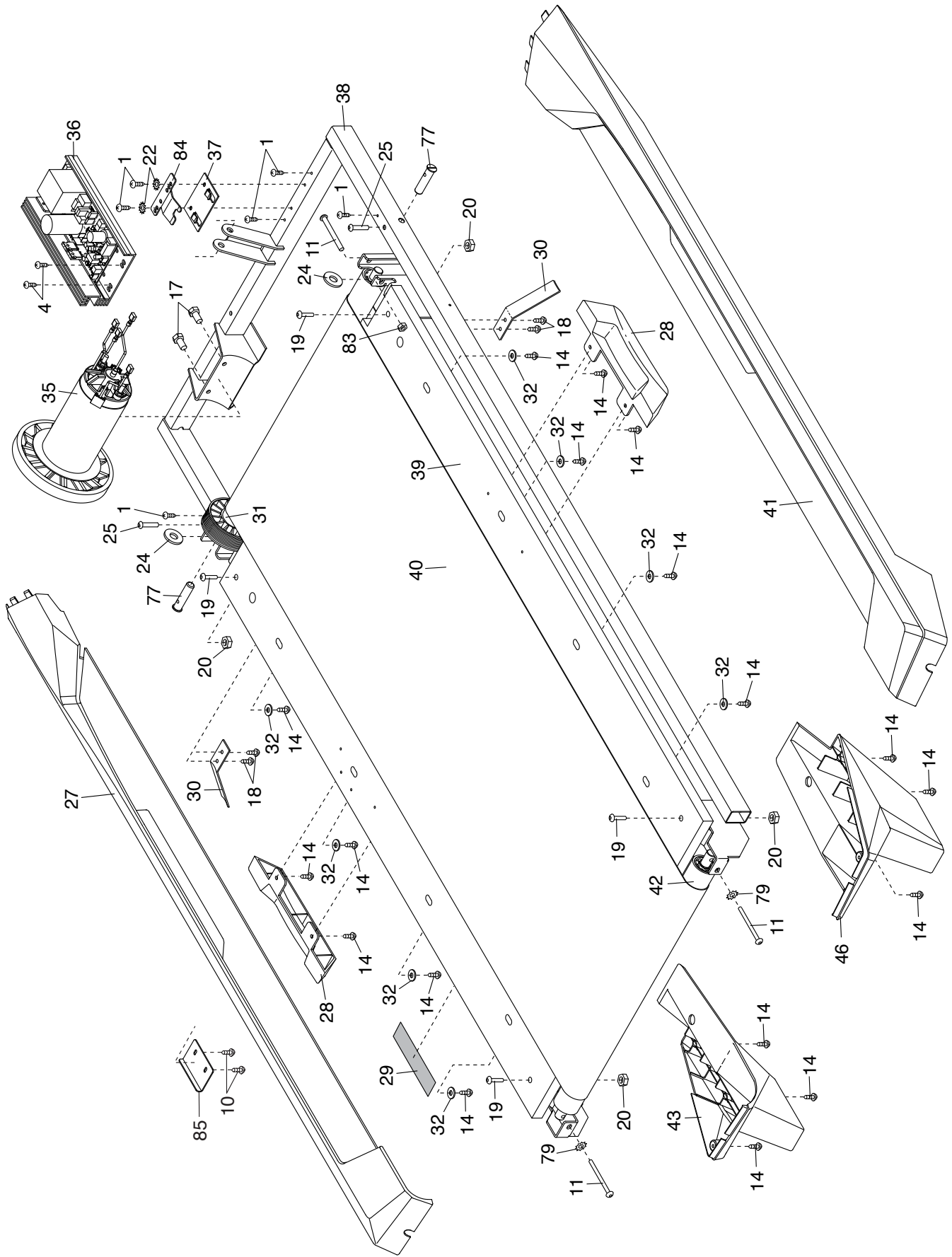

EXPLODED DRAWING B

Model No. 831.24843.3 R0315A

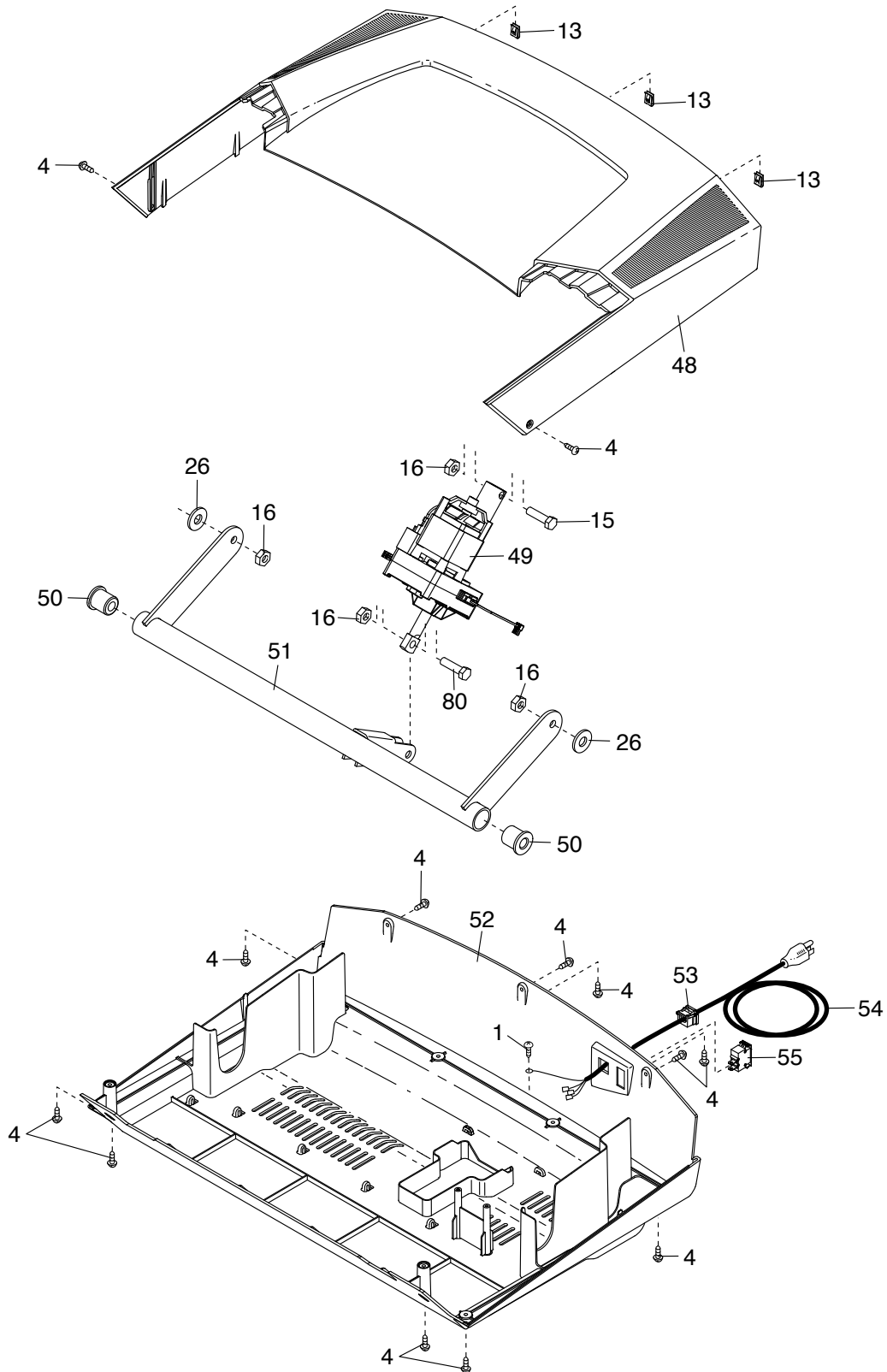

EXPLODED DRAWING C

Model No. 831.24843.3 R0315A

