

EXPLODED DRAWING A

Model No. 24850.2 R1117B

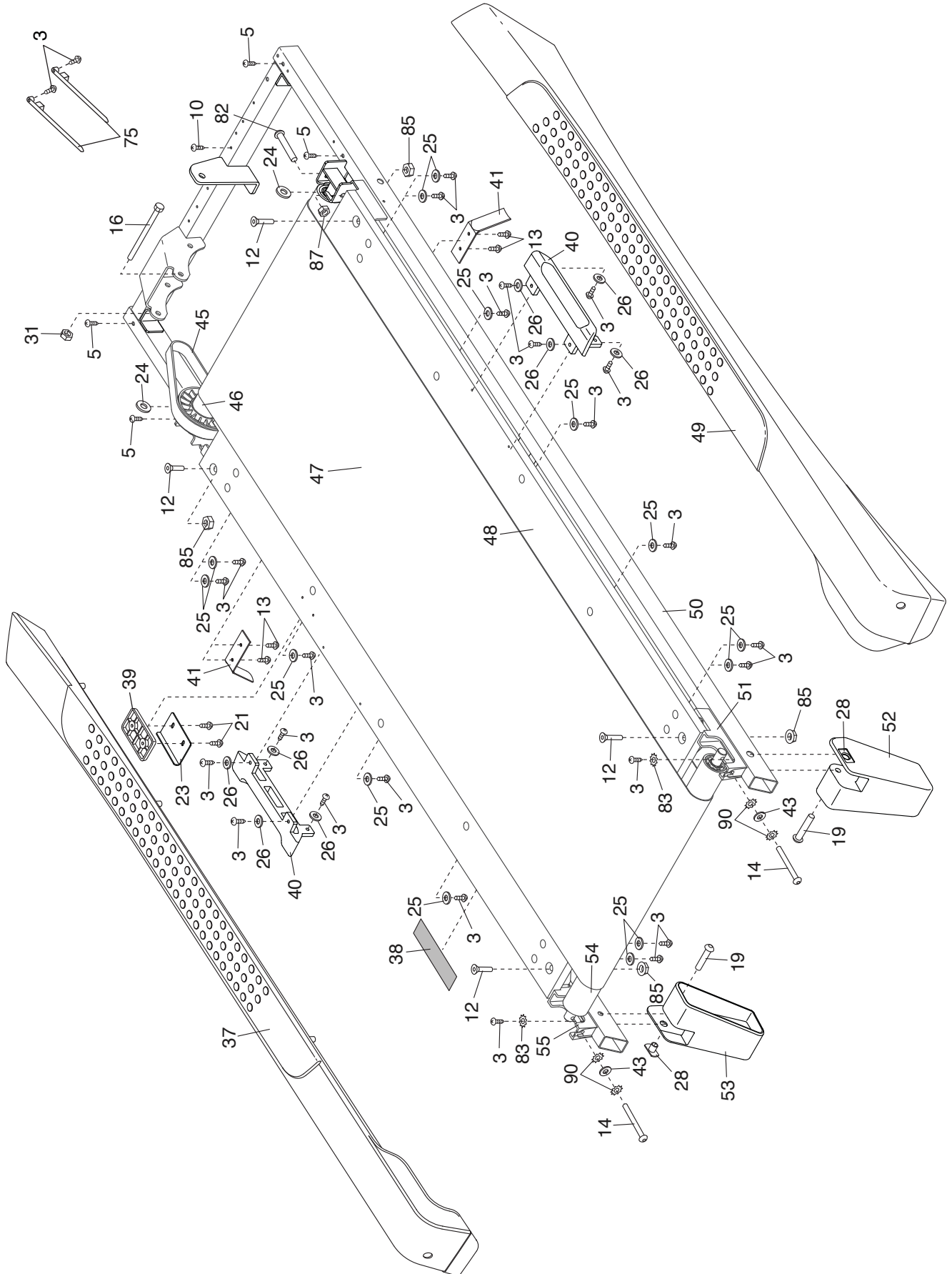

EXPLODED DRAWING B

Model No. 24850.2 R1117B

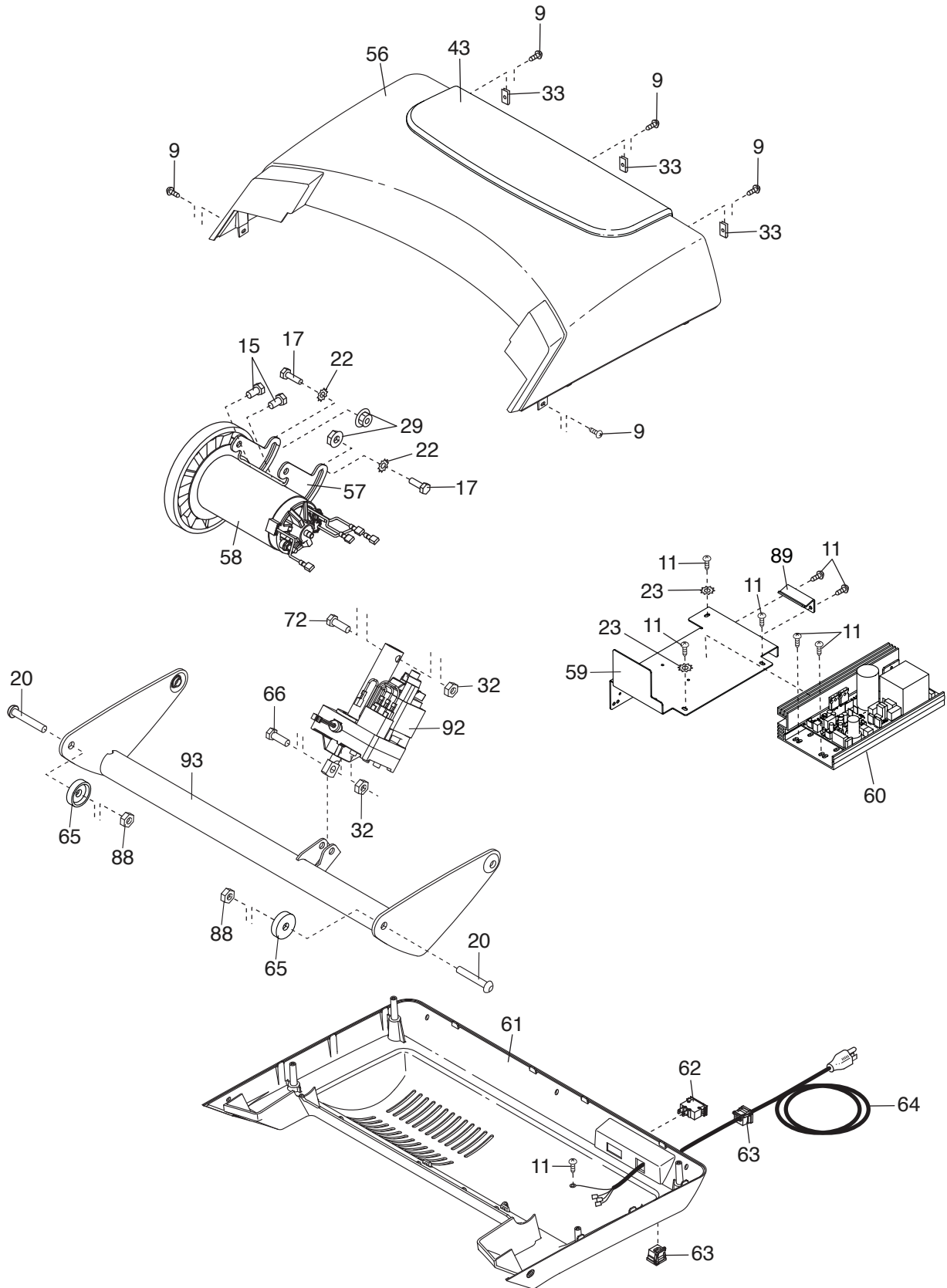

EXPLODED DRAWING C

Model No. 24850.2 R1117B

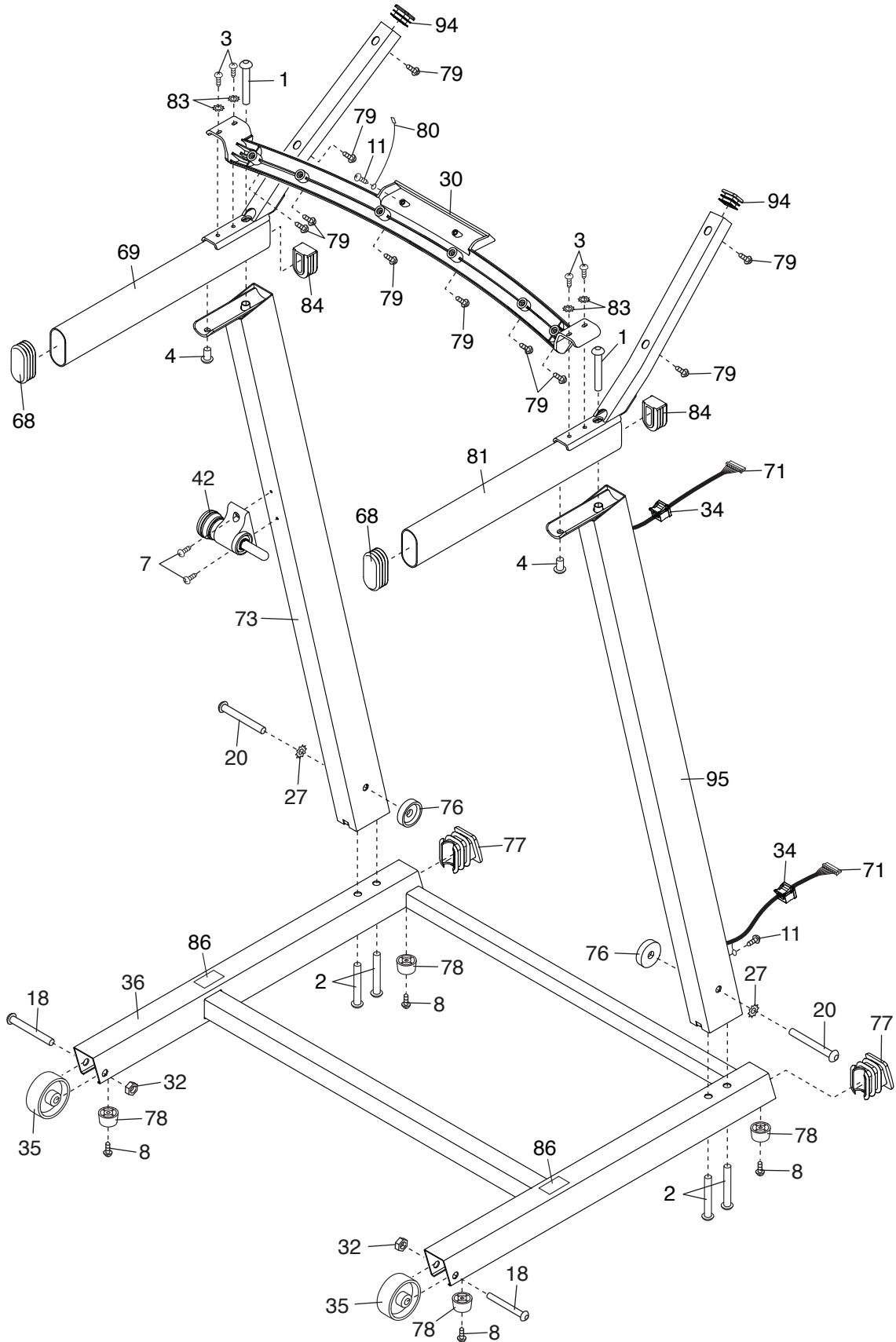

EXPLODED DRAWING D

Model No. 24850.2 R1117B

