

EXPLODED DRAWING A—Model No. 831.24855.8

R0909A

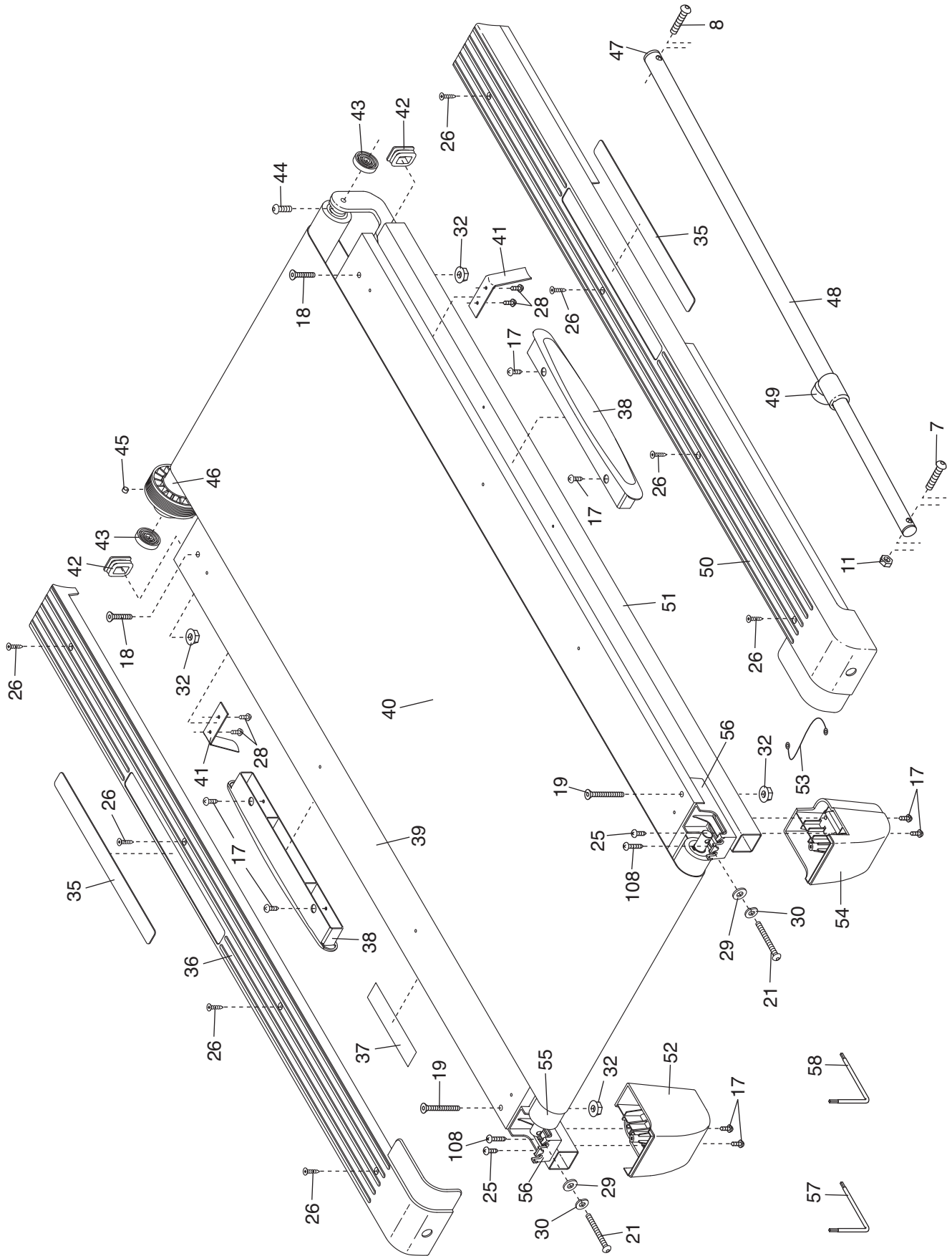

EXPLODED DRAWING B—Model No. 831.24855.8

R0909A

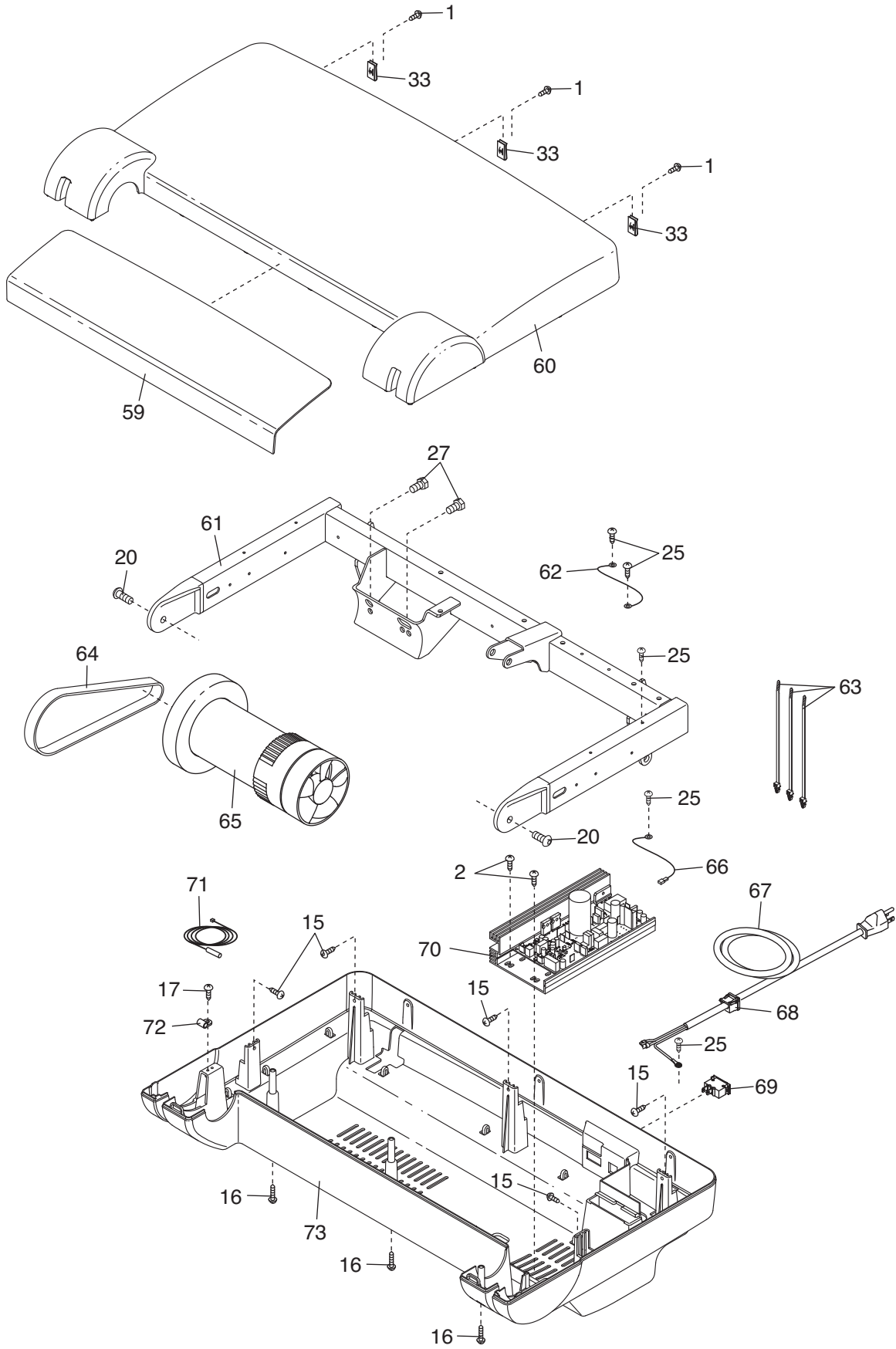

EXPLODED DRAWING C—Model No. 831.24855.8

R0909A

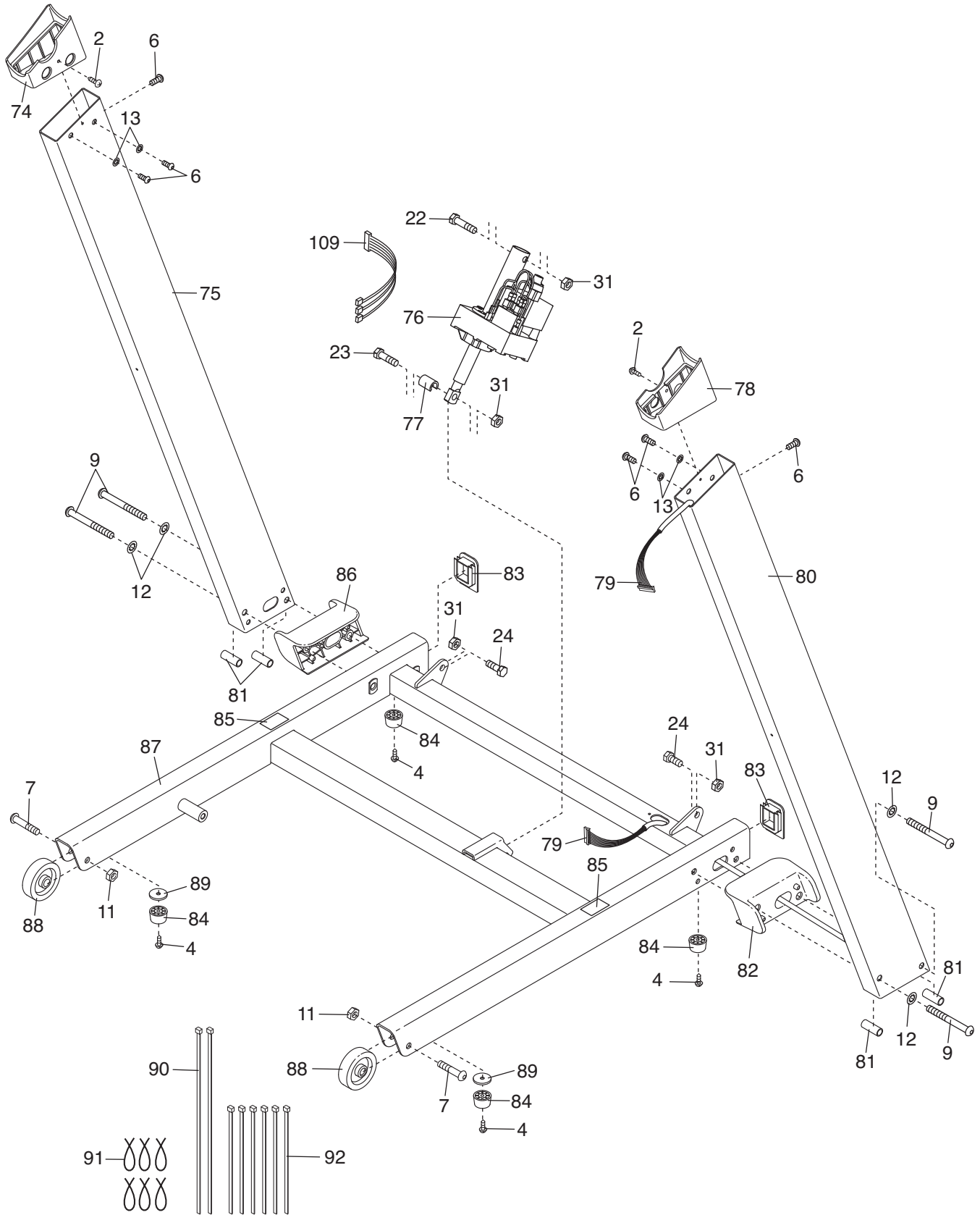

EXPLODED DRAWING D—Model No. 831.24855.8

R0909A

