

EXPLODED DRAWING A—Model No. 831.24855.2

R1008A

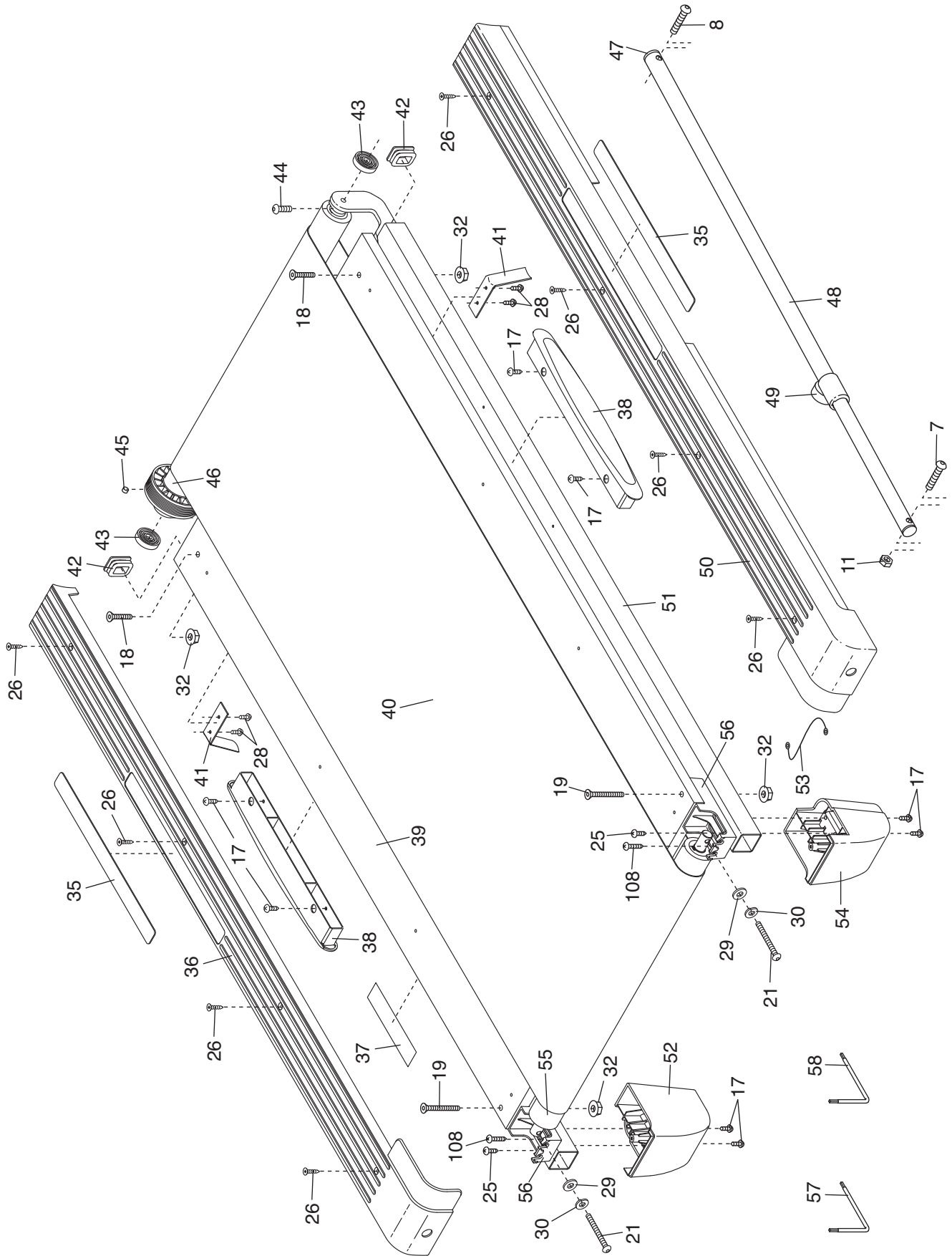

EXPLODED DRAWING B—Model No. 831.24855.2

R1008A

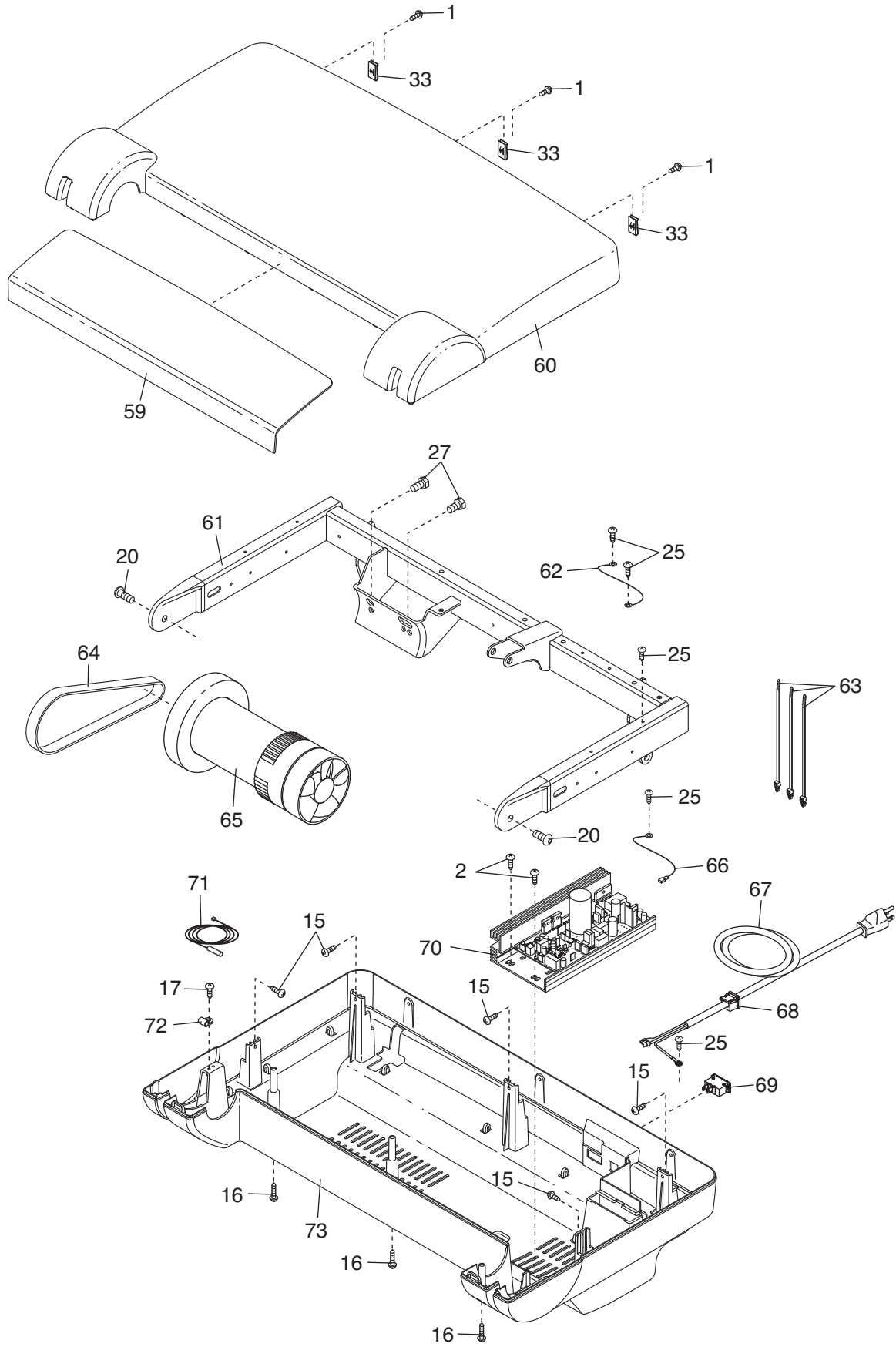

EXPLODED DRAWING C—Model No. 831.24855.2

R1008A

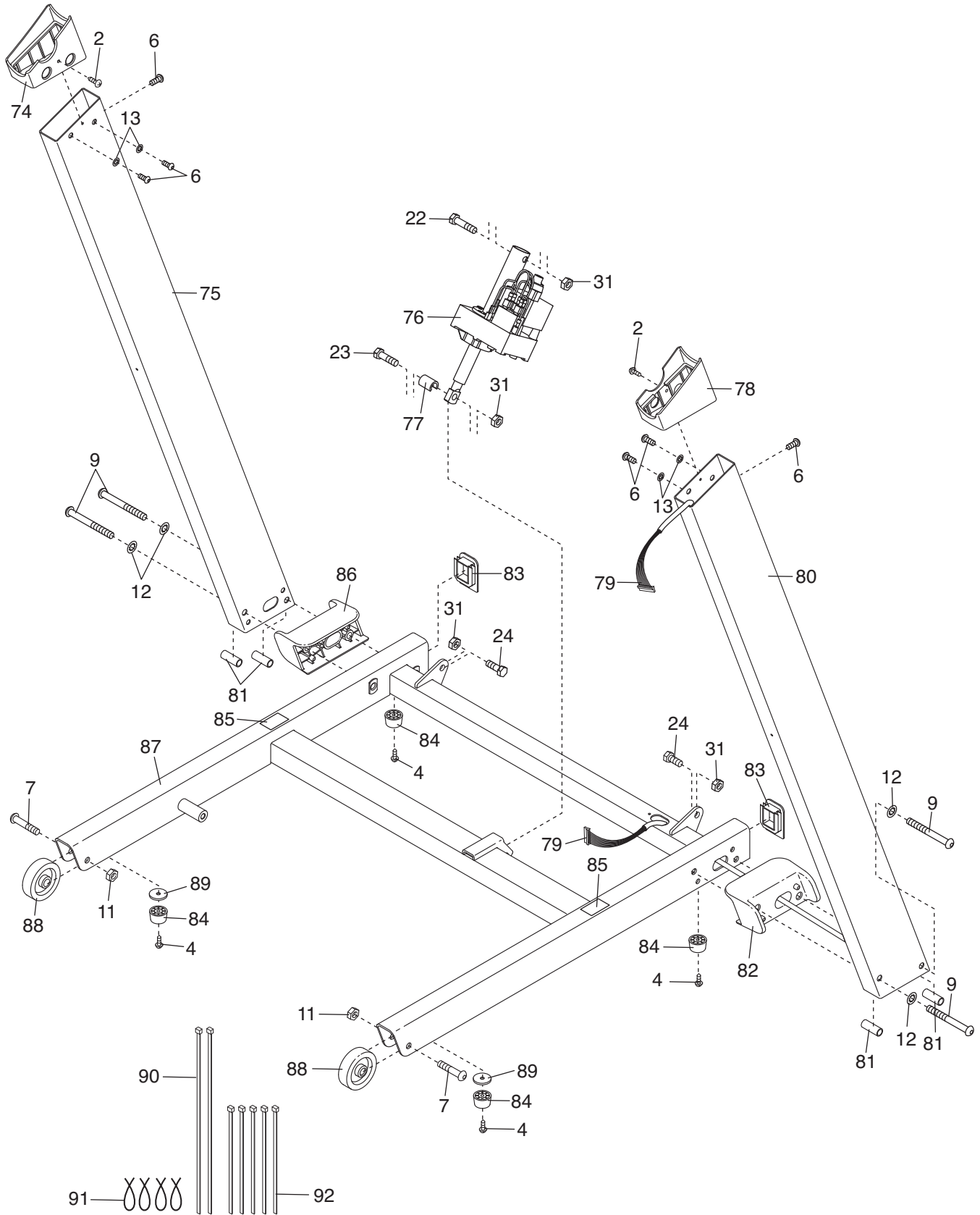

EXPLODED DRAWING D—Model No. 831.24855.2

R1008A

