

EXPLODED DRAWING A—Model No. 831.24855.3

R0908A

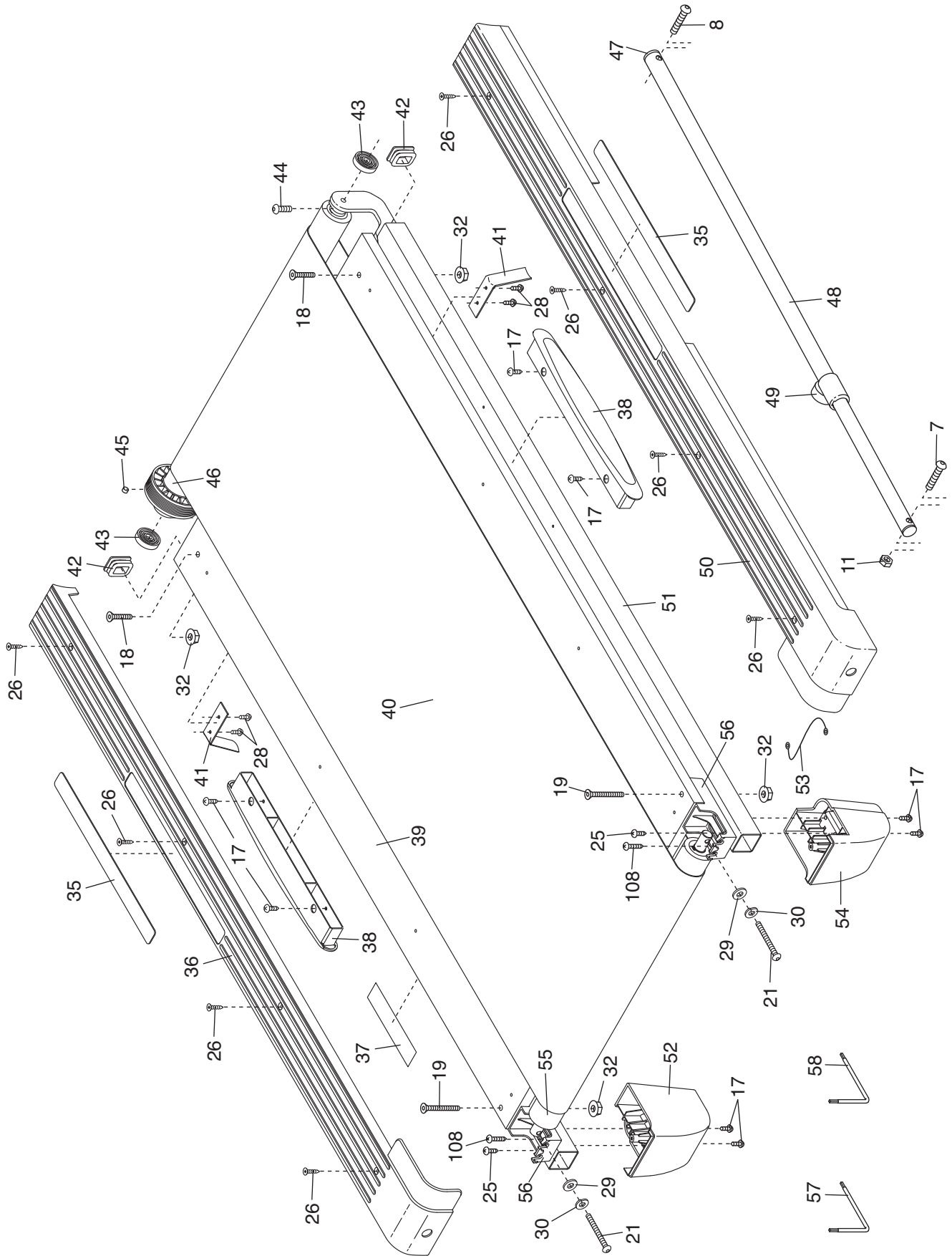

EXPLODED DRAWING B—Model No. 831.24855.3

R0908A

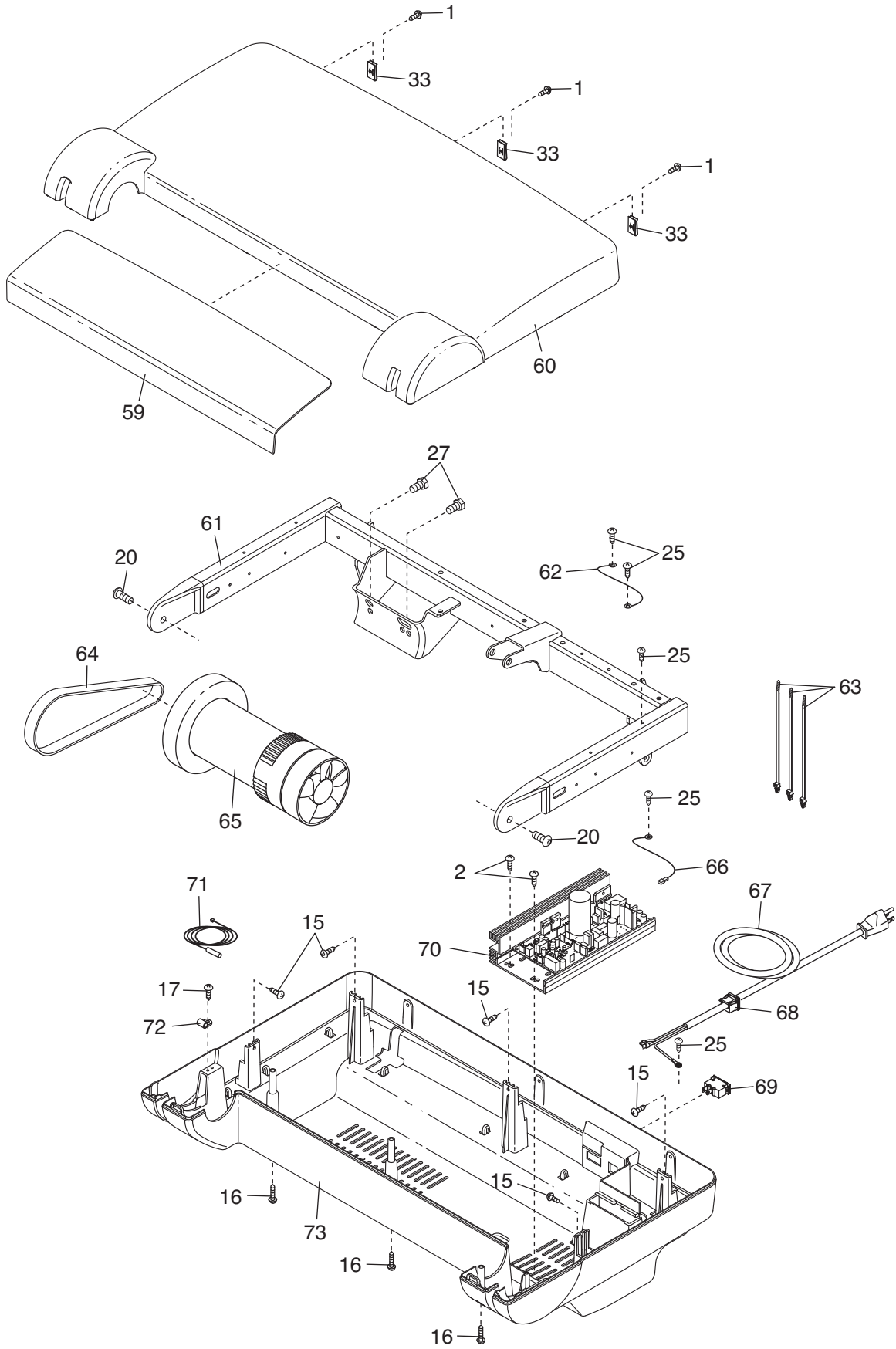

EXPLODED DRAWING D—Model No. 831.24855.3

R0908A

