

# EXPLODED DRAWING A—Model No. 831.24865.5

R0609A

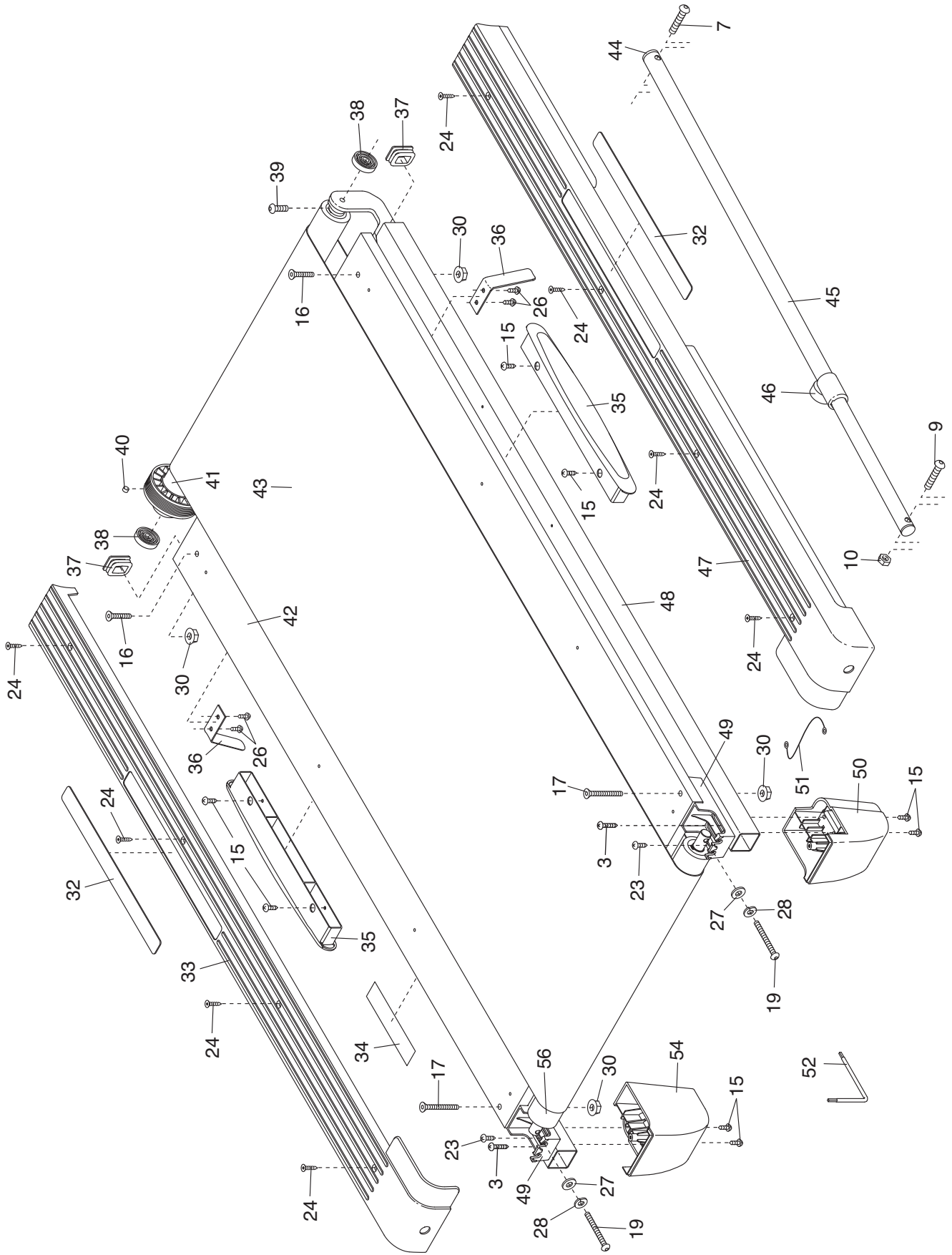

# EXPLODED DRAWING B—Model No. 831.24865.5

R0609A

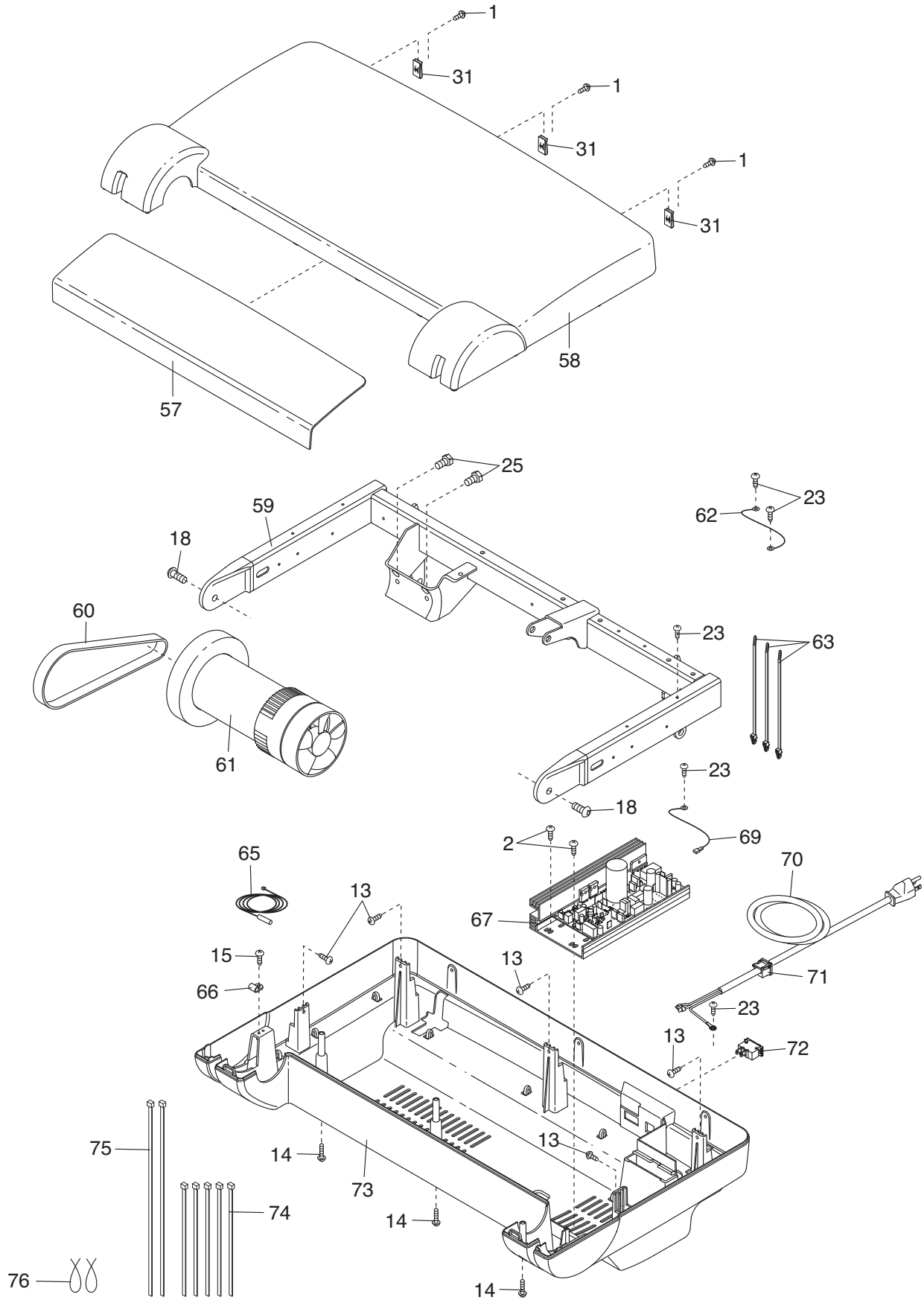

# EXPLODED DRAWING C—Model No. 831.24865.5

R0609A

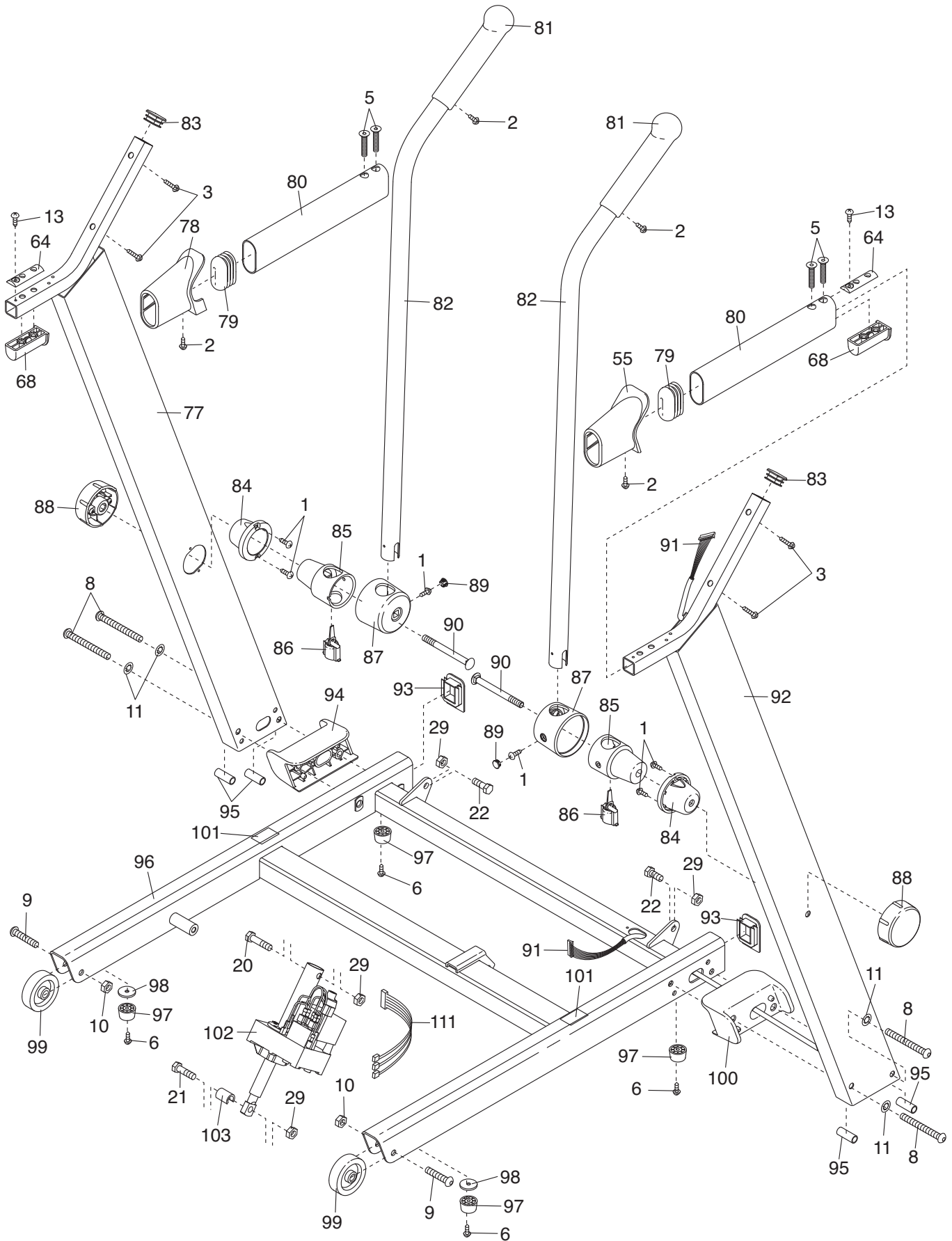

# EXPLODED DRAWING D—Model No. 831.24865.5

R0609A

