

# EXPLODED DRAWING A

Model No. 24885.0 R0619A

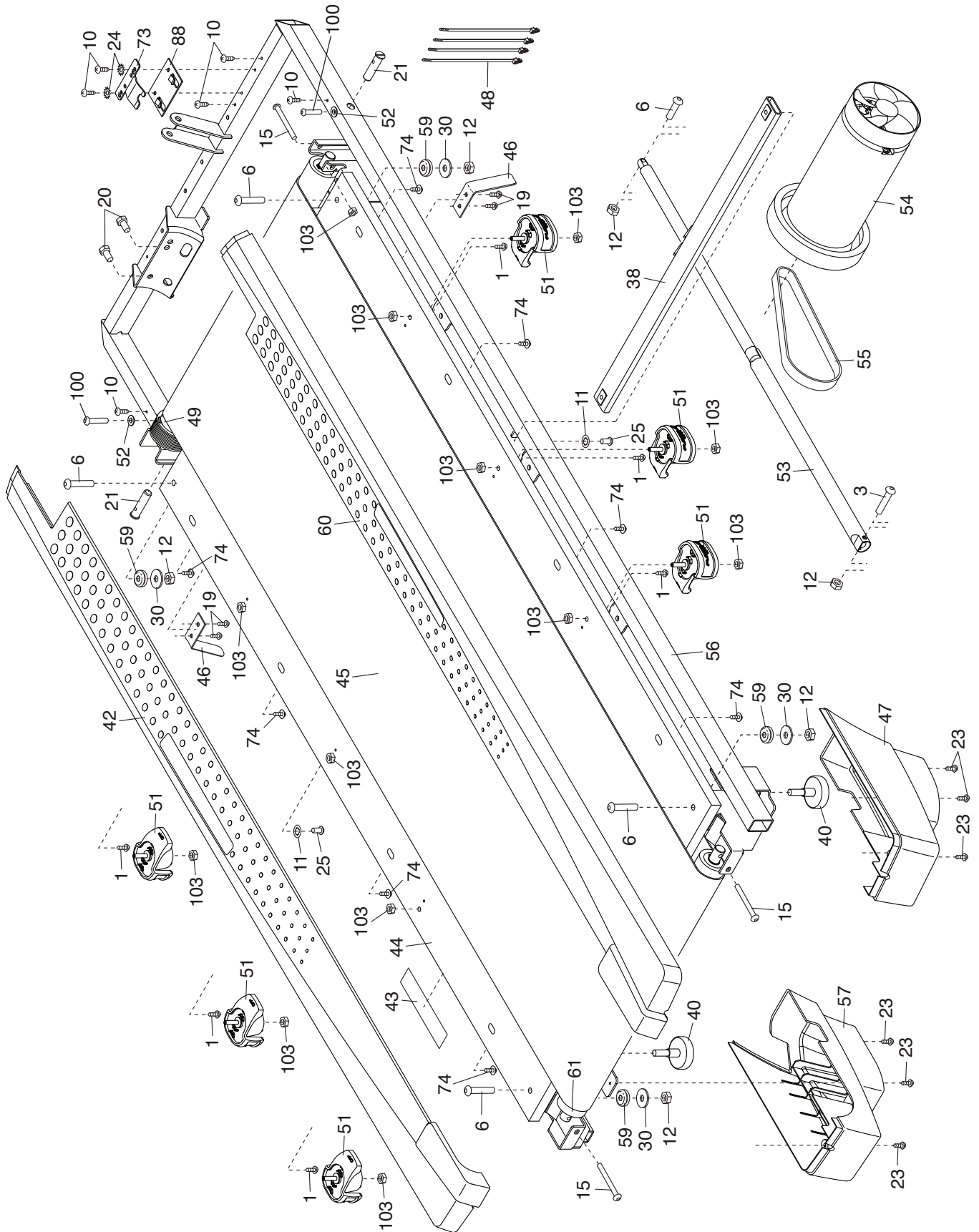

# EXPLODED DRAWING B

Model No. 24885.0 R0619A

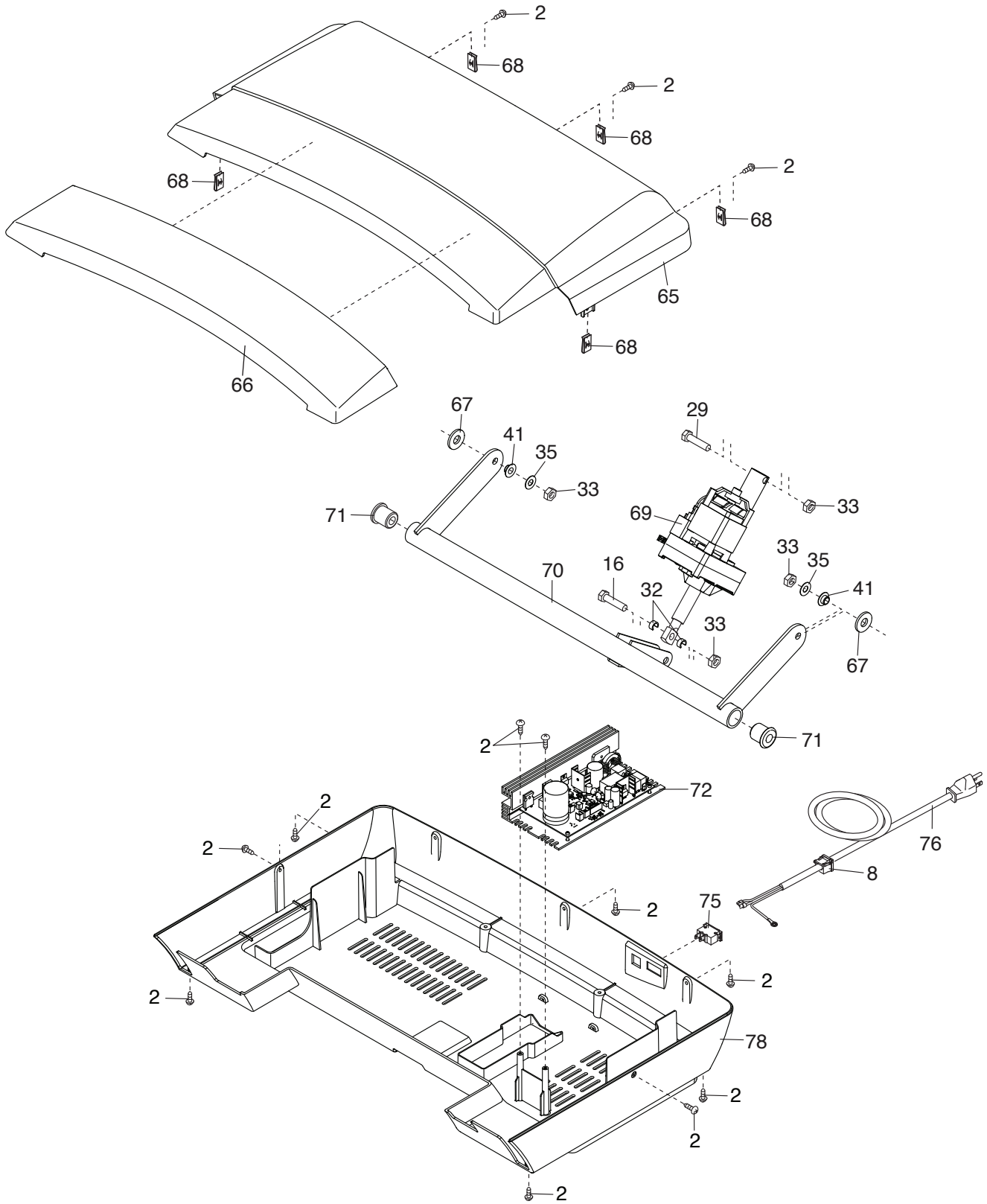

# EXPLODED DRAWING C

Model No. 24885.0 R0619A

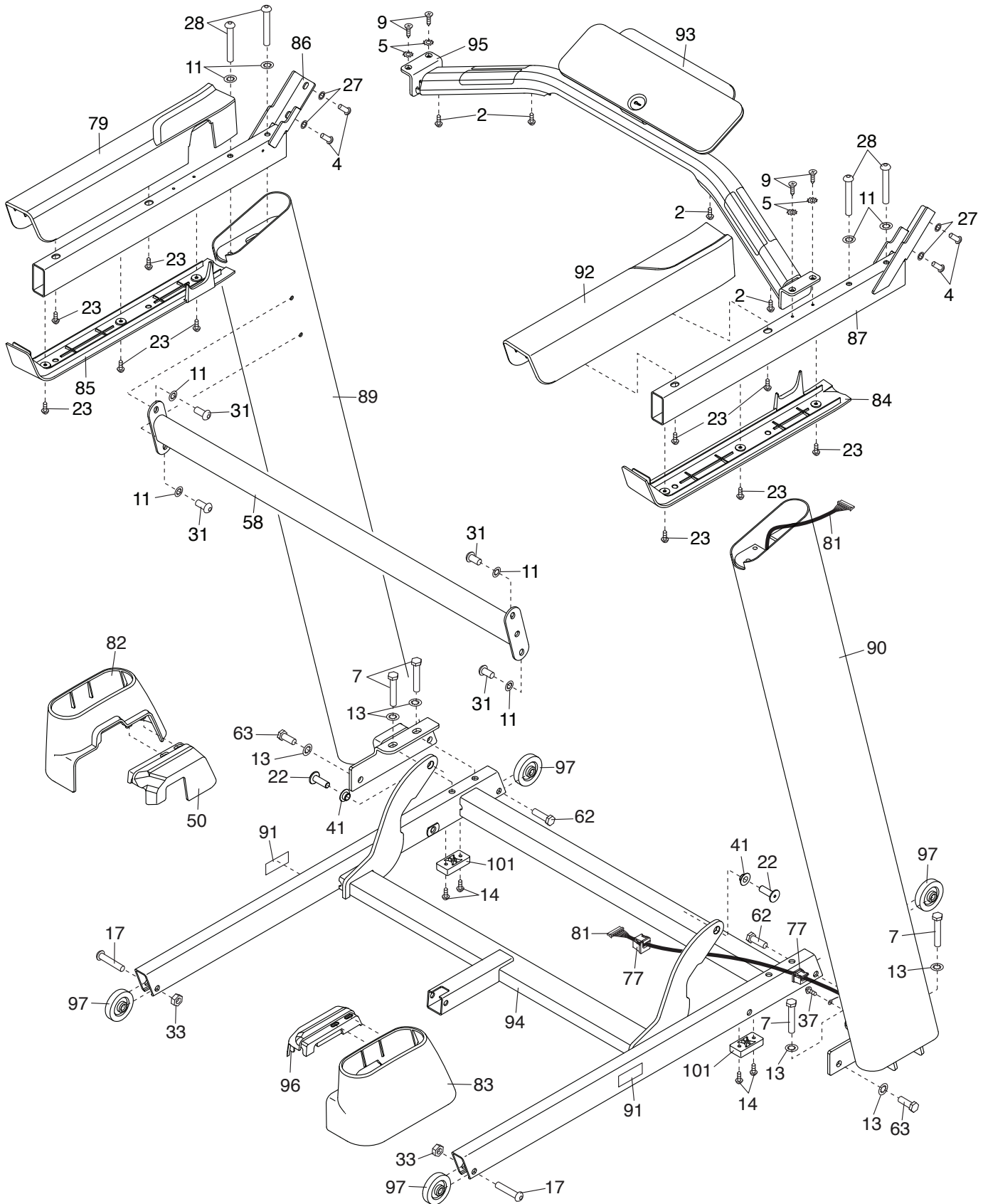

# EXPLODED DRAWING D

Model No. 24885.0 R0619A

