

EXPLODED DRAWING A

Model No. NTL19010.1 R1011A

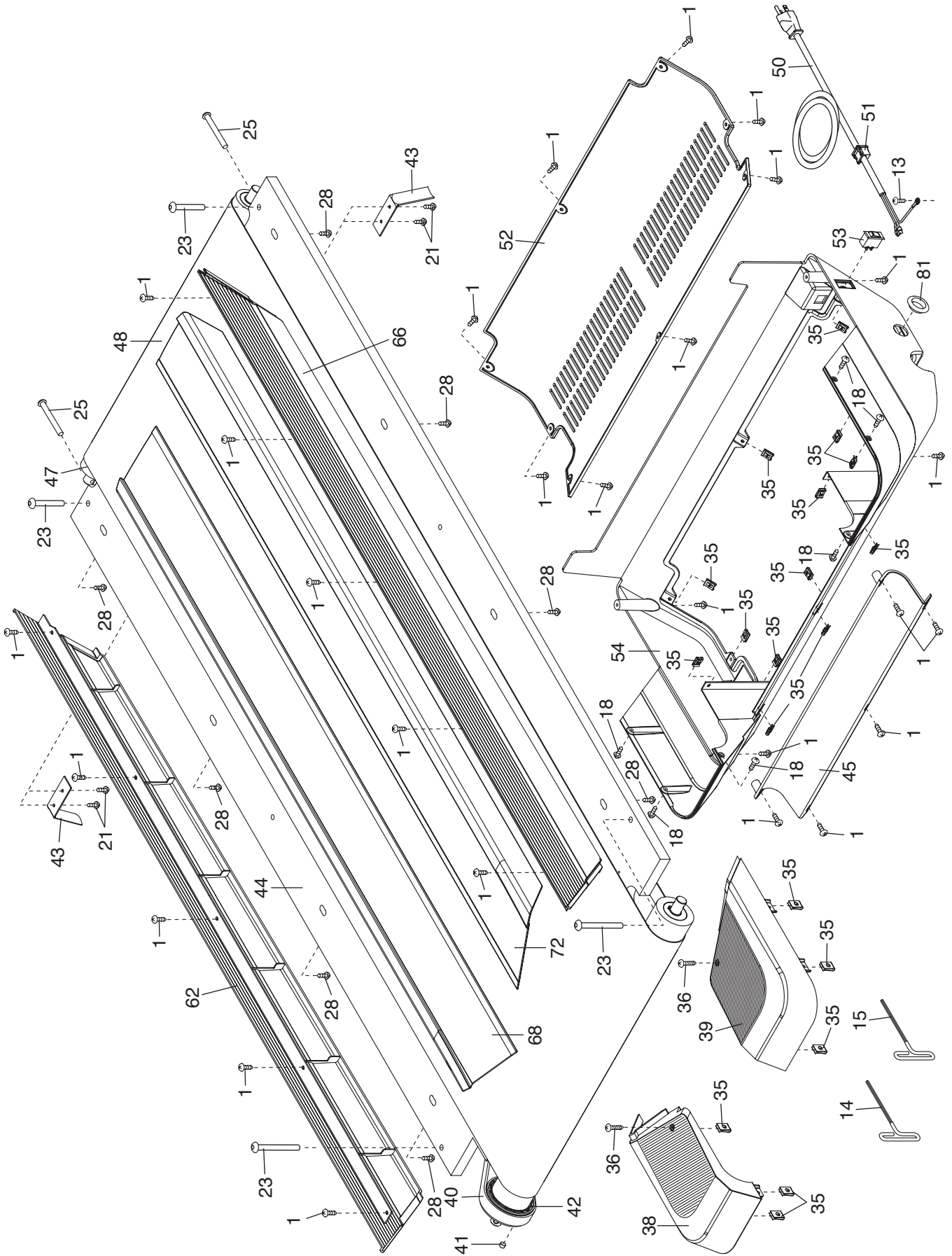

EXPLODED DRAWING B

Model No. NTL19010.1 R1011A

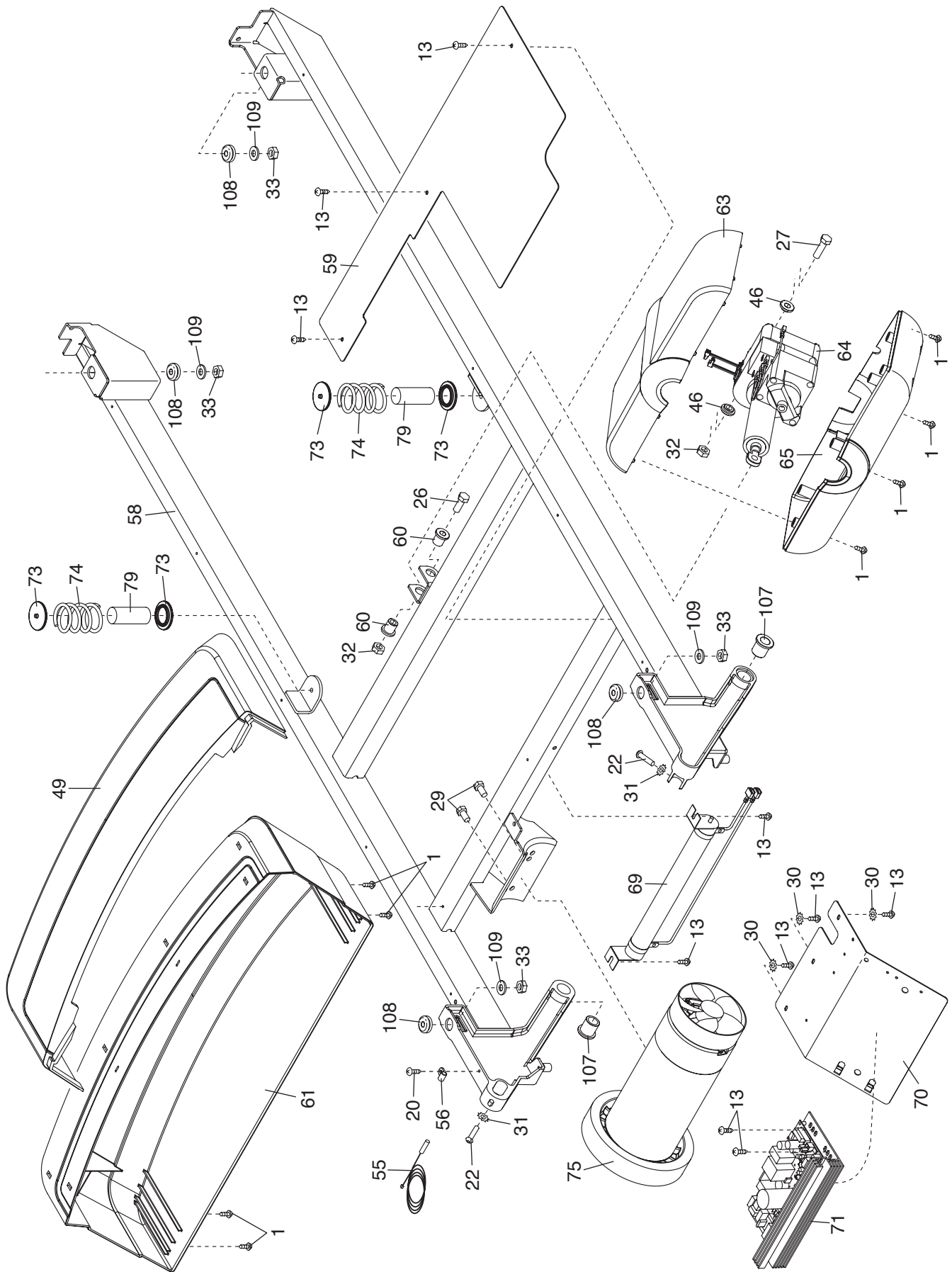

EXPLODED DRAWING C

Model No. NTL19010.1 R1011A

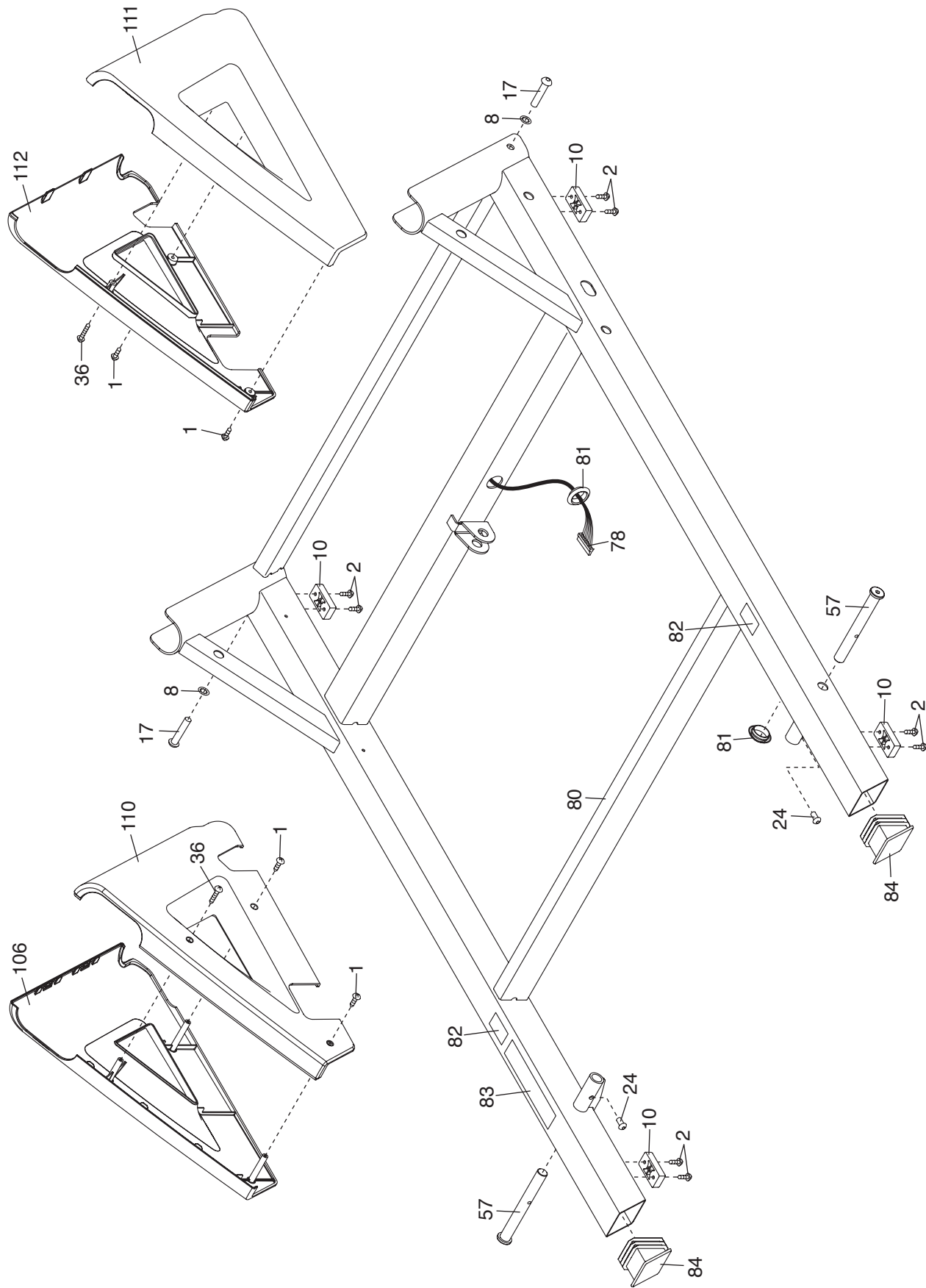

EXPLODED DRAWING D

Model No. NTL19010.1 R1011A

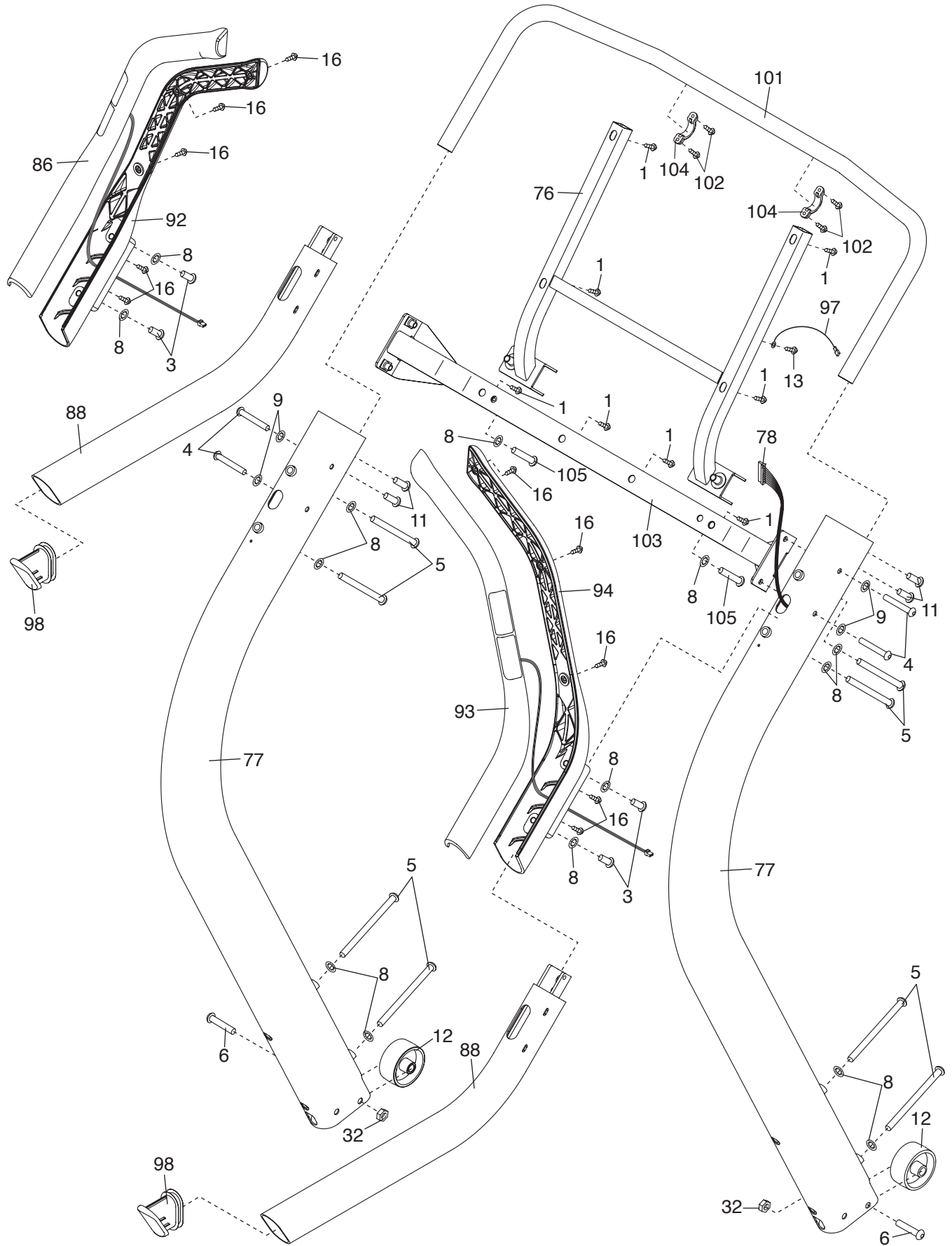

EXPLODED DRAWING E

Model No. NTL19010.1 R1011A

