

# EXPLODED DRAWING A

Model No. NTL60010.2 R1210A

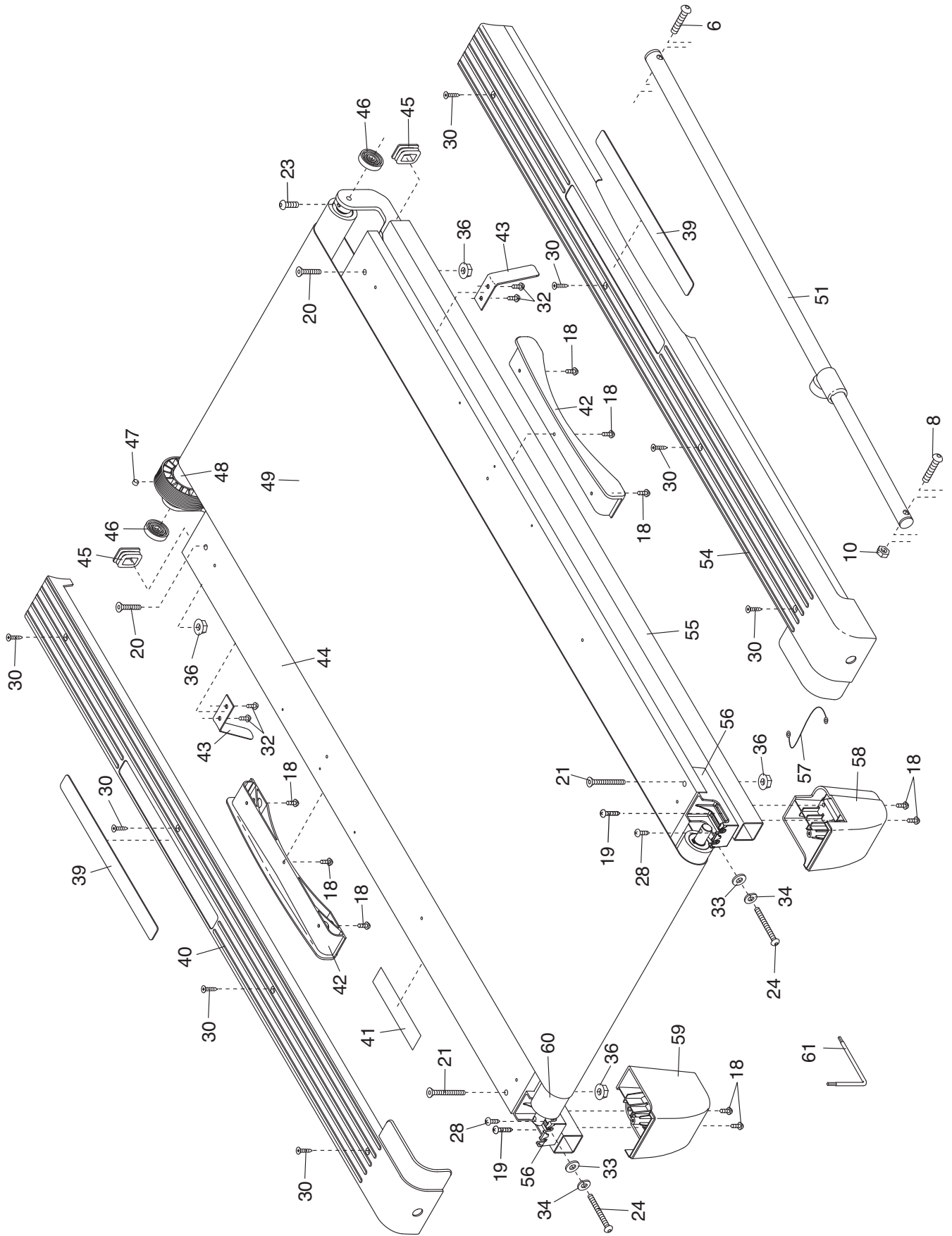

# EXPLODED DRAWING B

Model No. NTL60010.2 R1210A

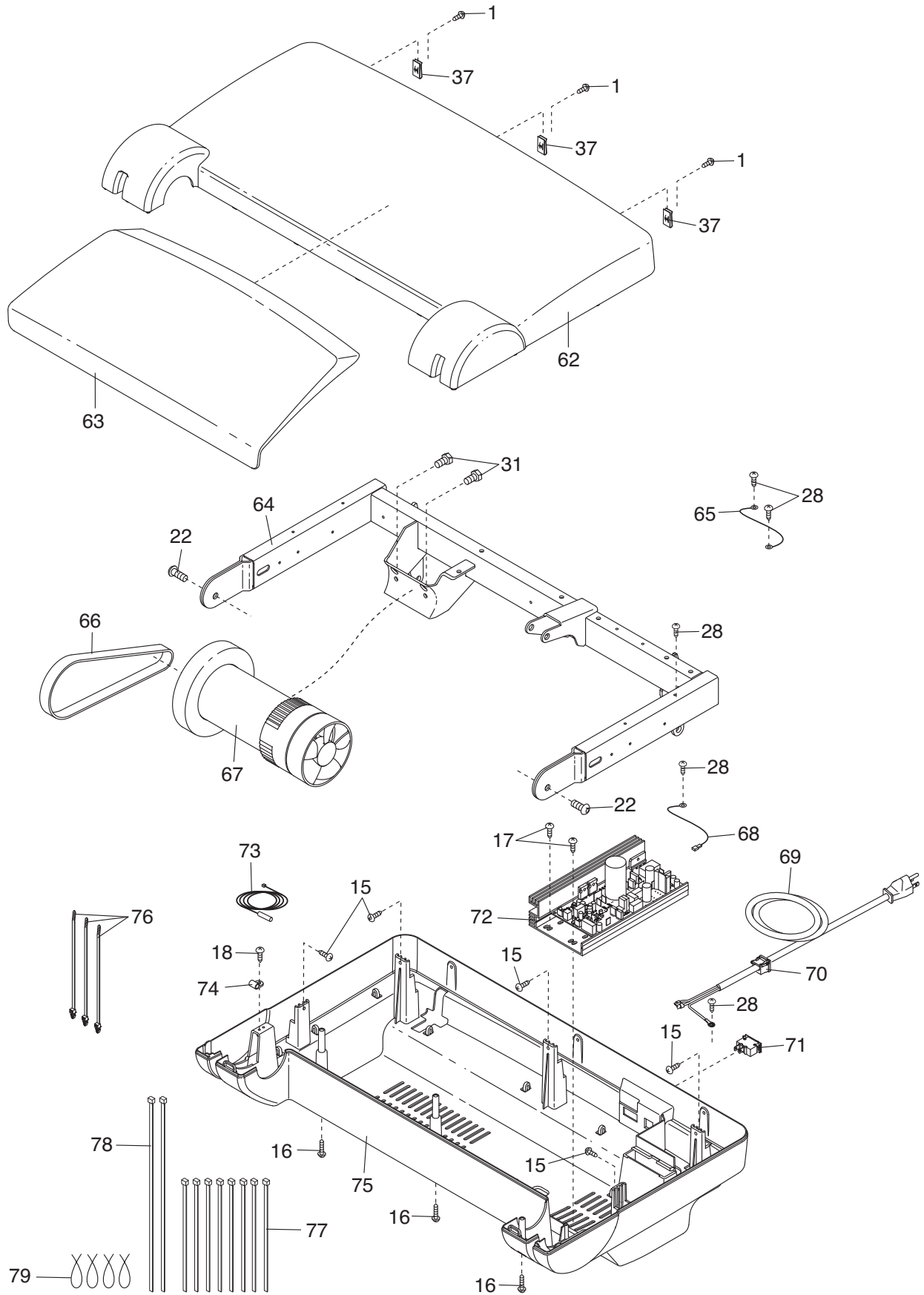

# EXPLODED DRAWING C

Model No. NTL60010.2 R1210A

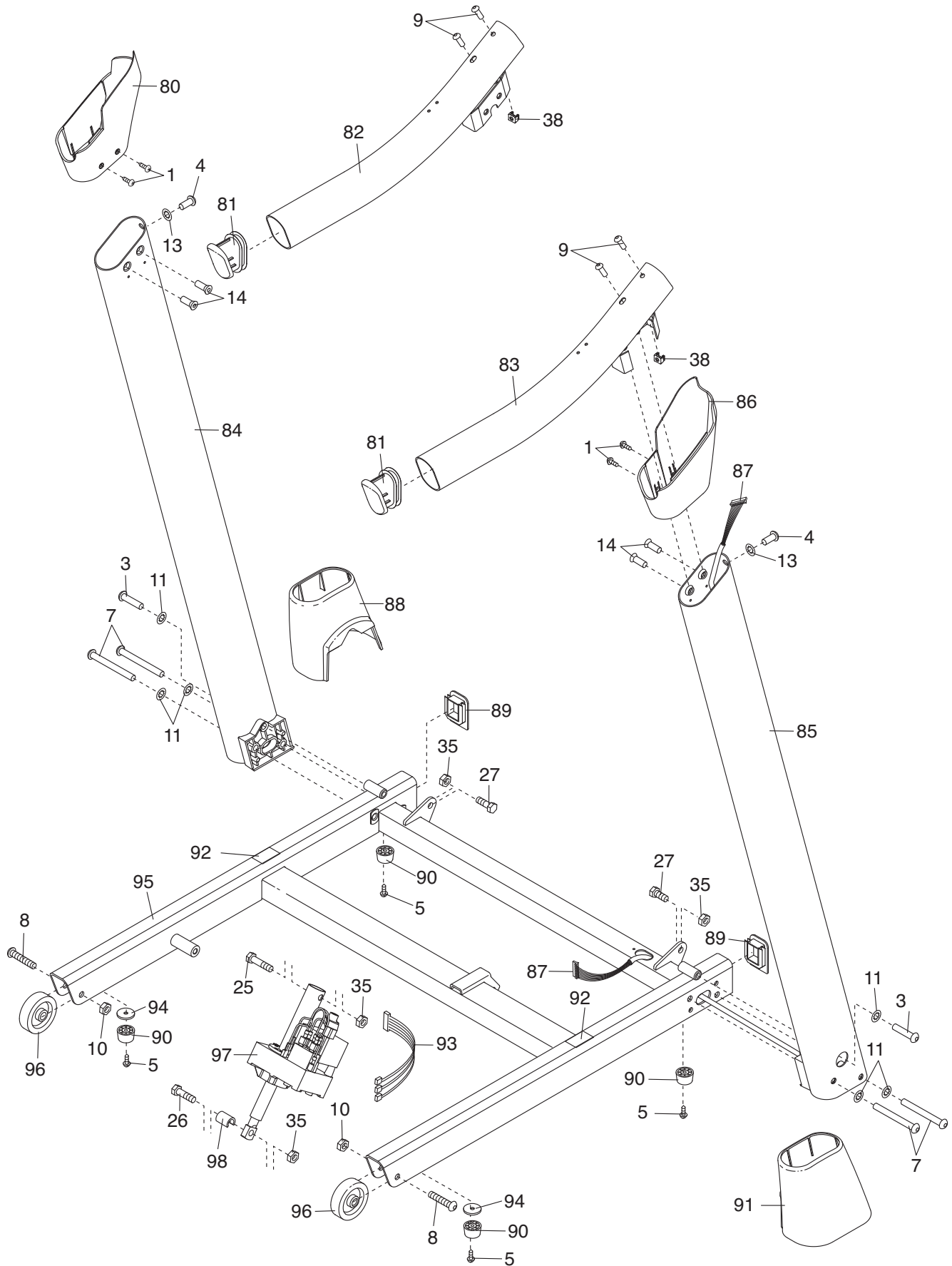

# EXPLODED DRAWING D

Model No. NTL60010.2 R1210A

