

EXPLODED DRAWING A—Model No. 831.24966.0

R1209A

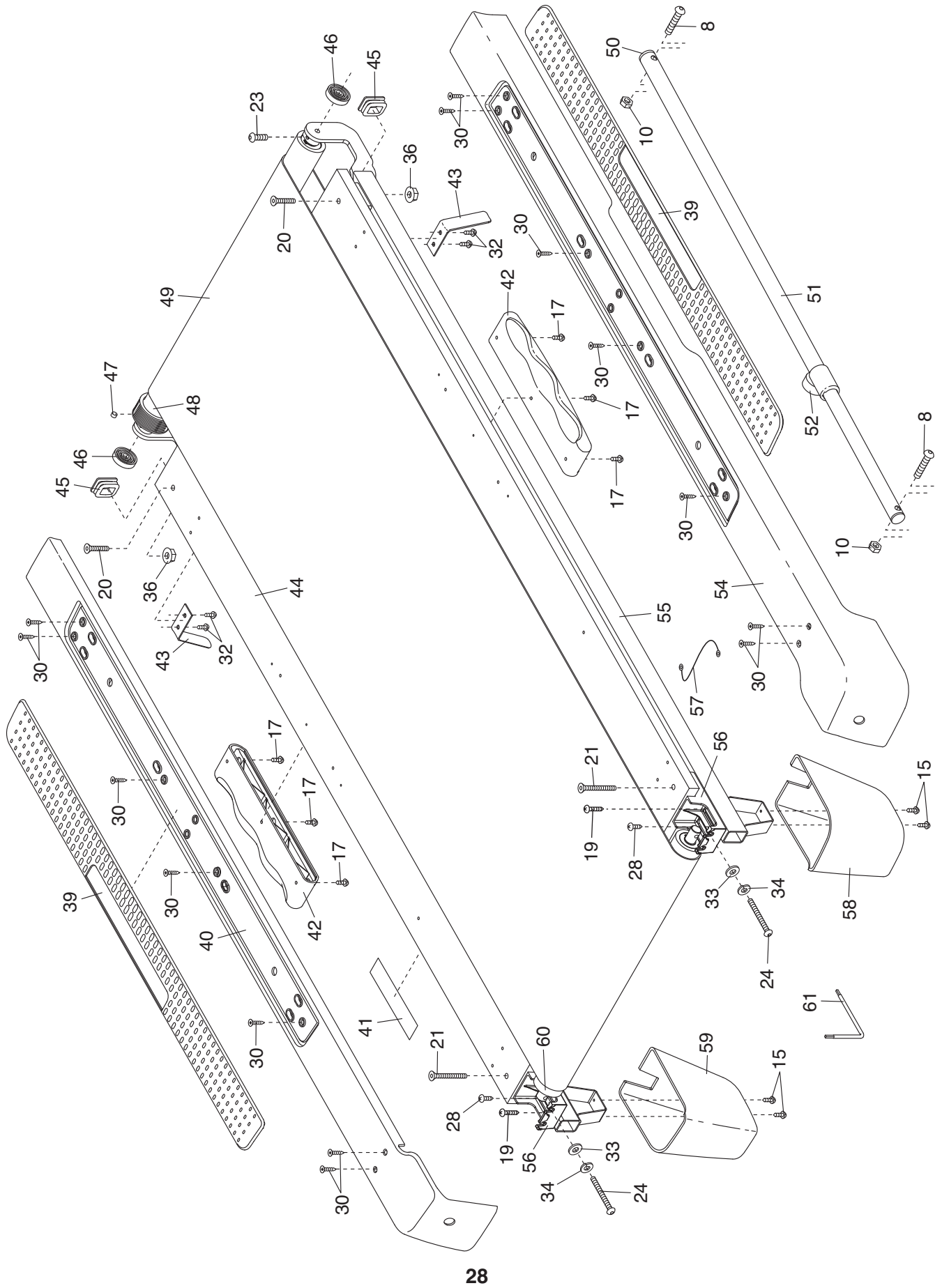

EXPLODED DRAWING B—Model No. 831.24966.0

R1209A

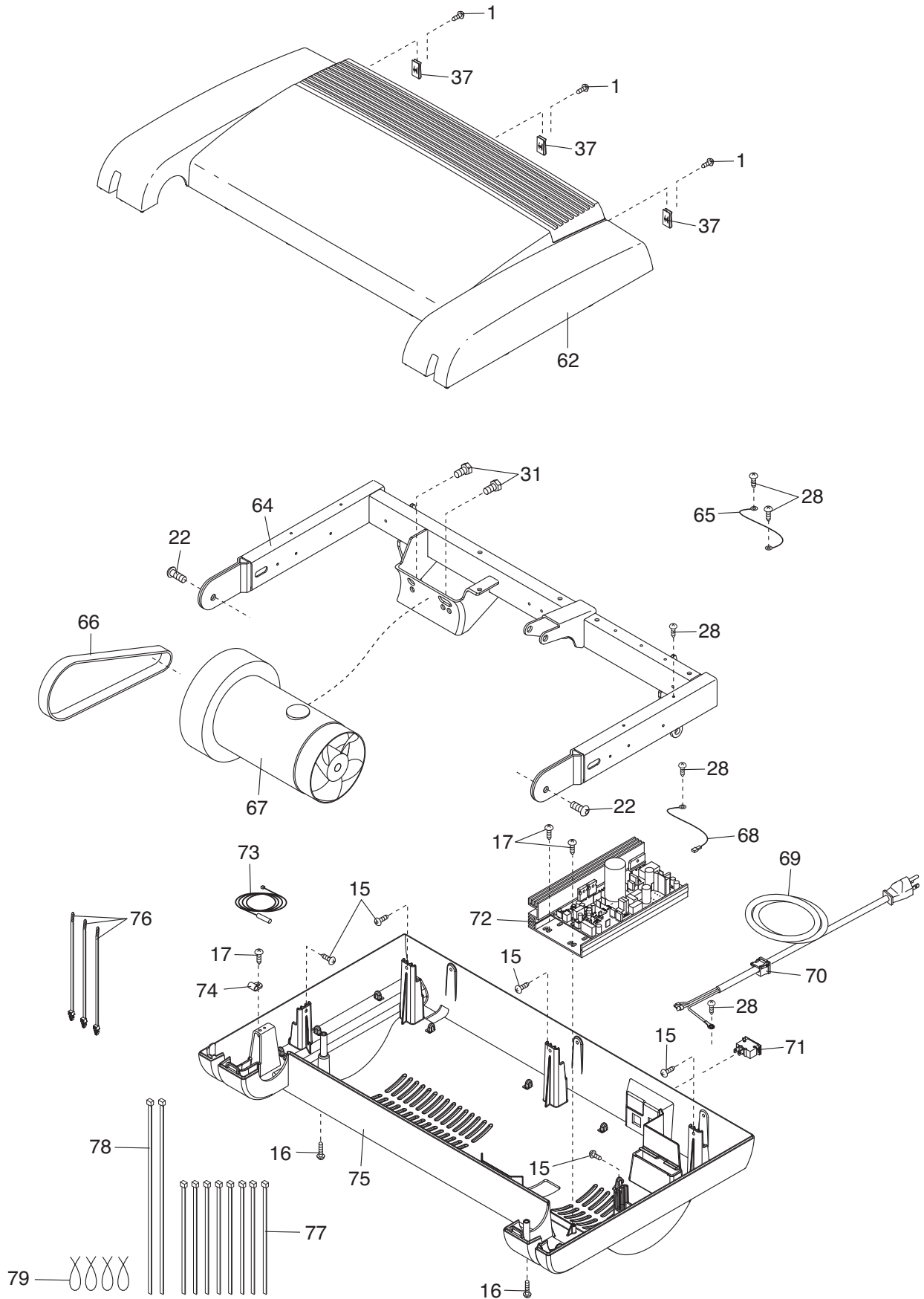

EXPLODED DRAWING C—Model No. 831.24966.0

R1209A

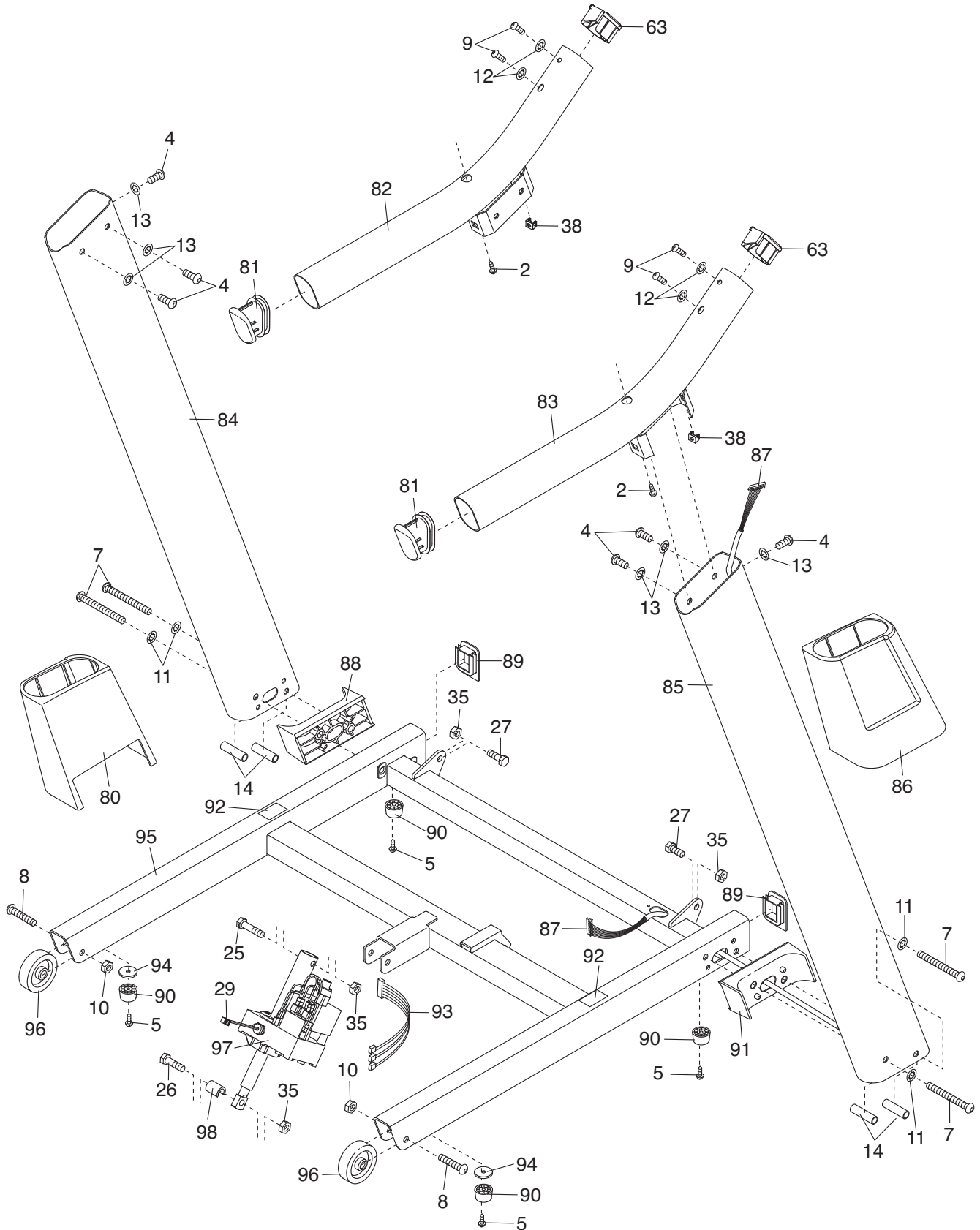

EXPLODED DRAWING D—Model No. 831.24966.0

R1209A

