

EXPLODED DRAWING B

Model No. NTL17010.0 R1110A

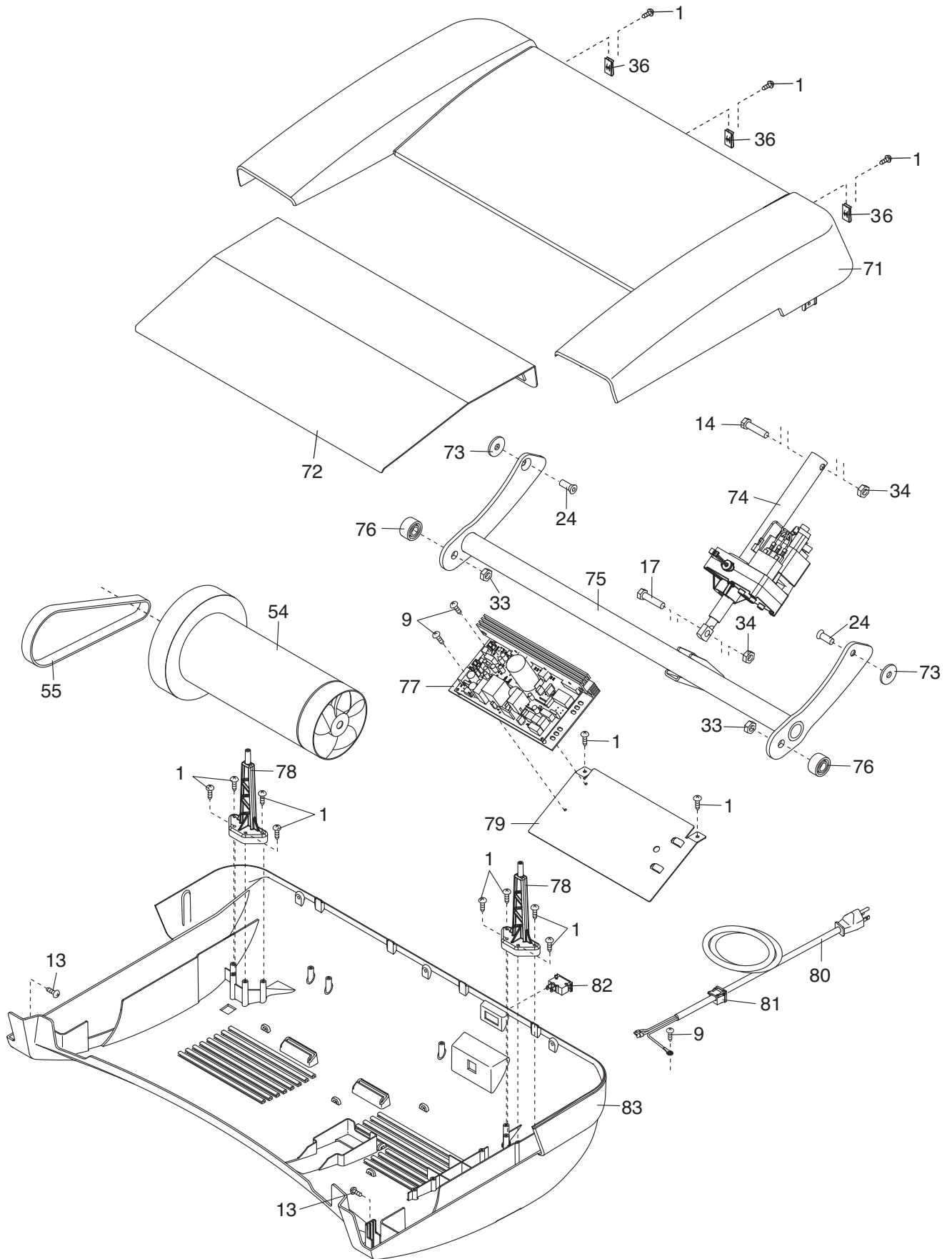

EXPLODED DRAWING C

Model No. NTL17010.0 R1110A

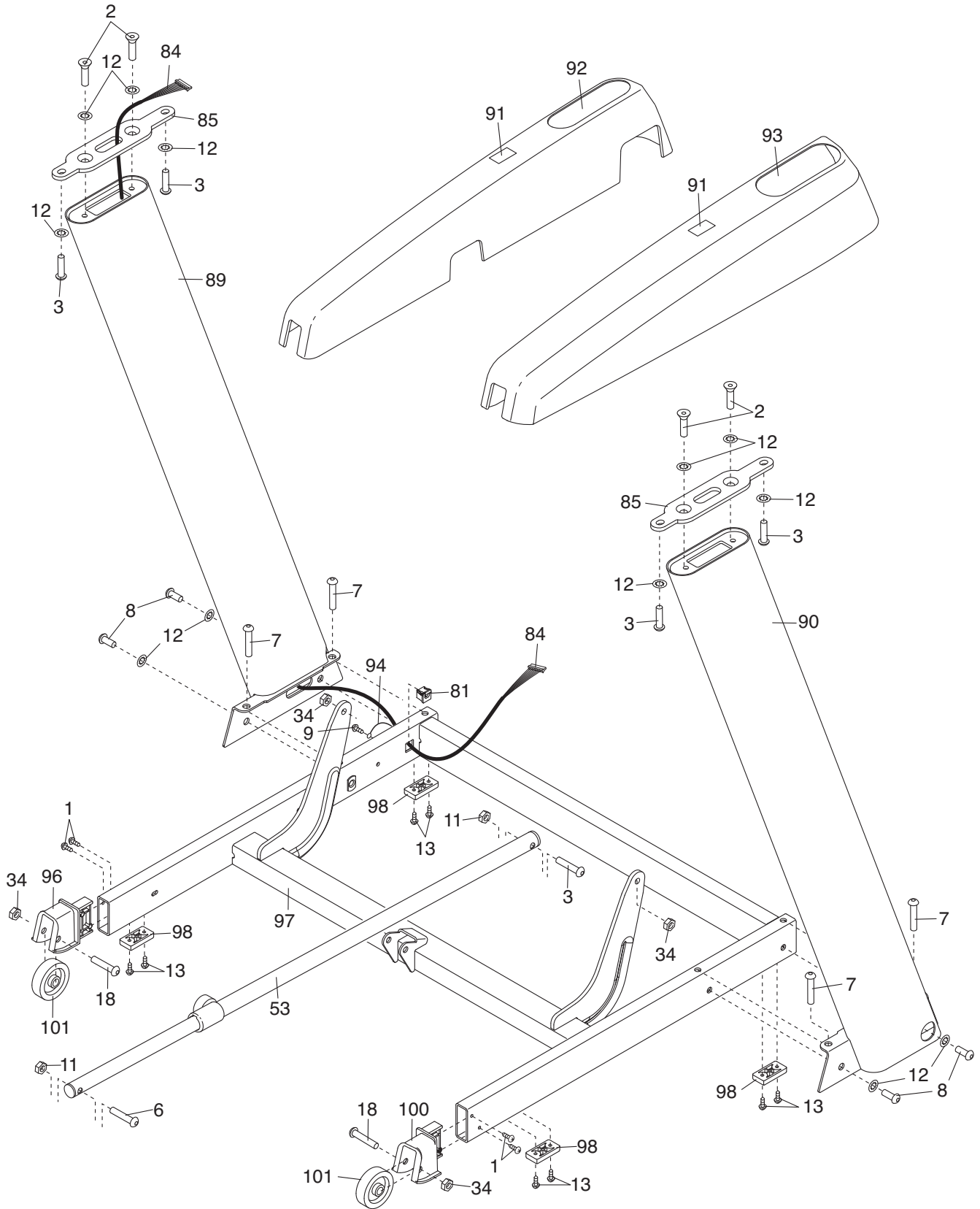

EXPLODED DRAWING D

Model No. NTL17010.0 R1110A

