

# EXPLODED DRAWING A

Model No. 831.25018.0 R0714A

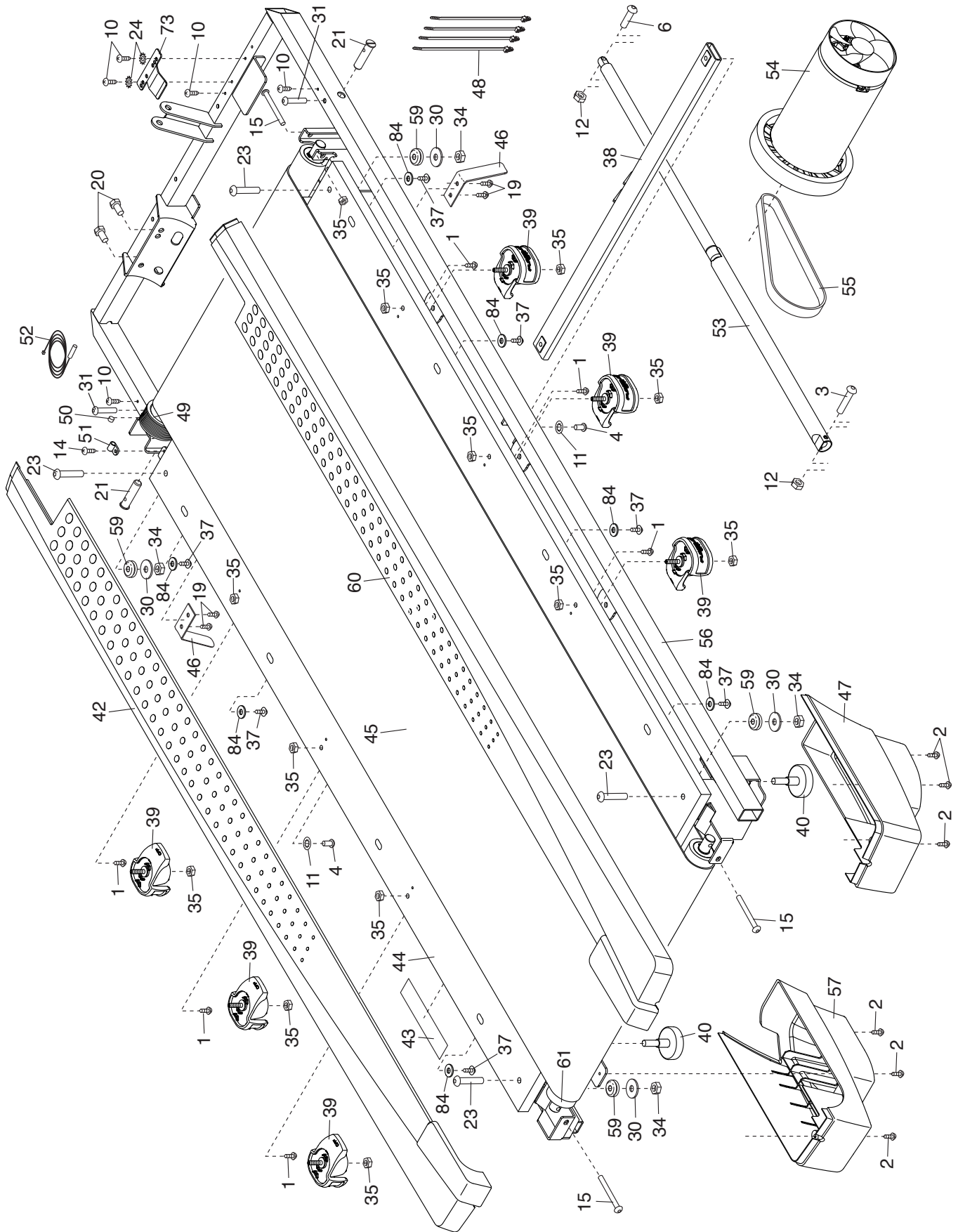

# EXPLODED DRAWING B

Model No. 831.25018.0 R0714A

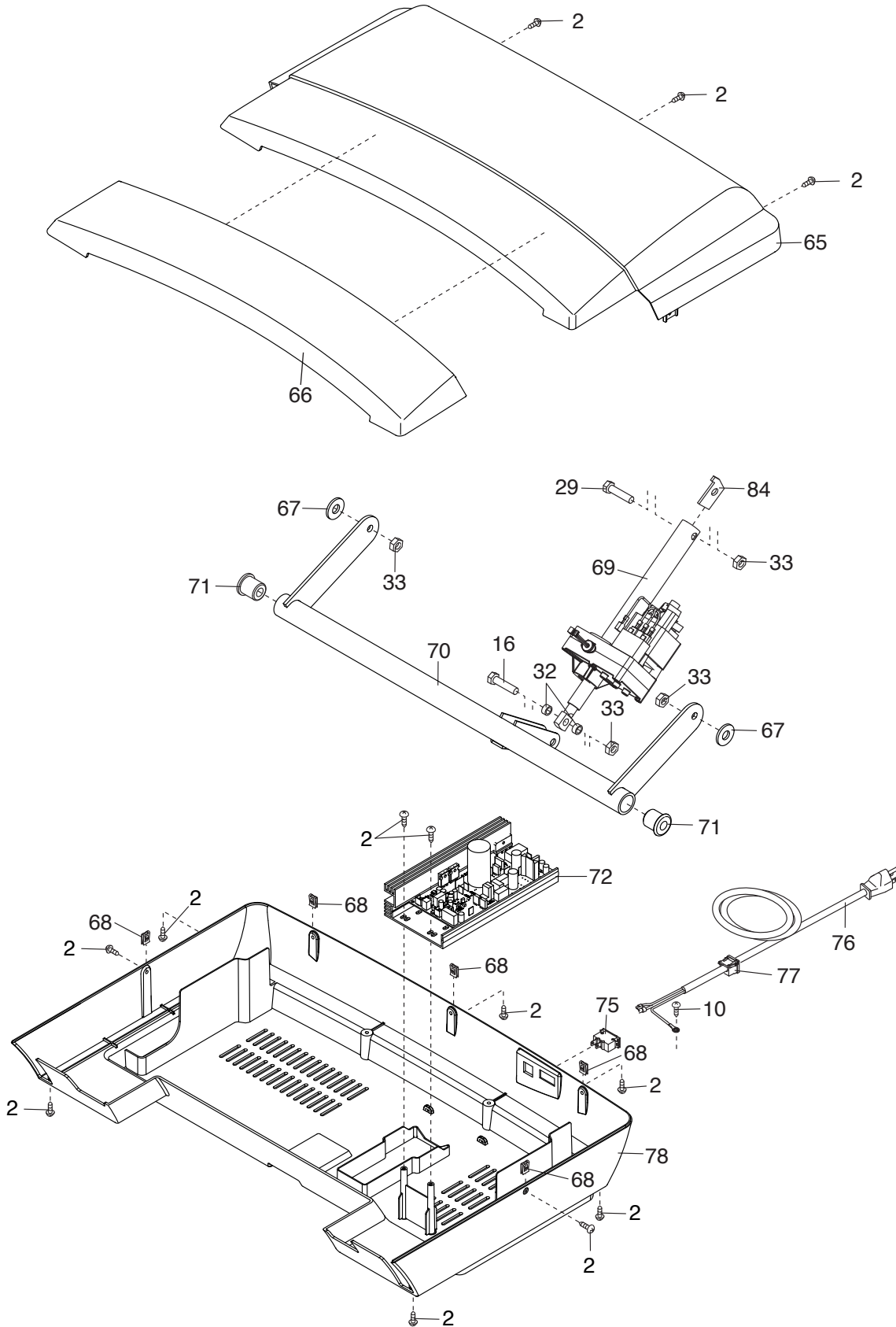

# EXPLODED DRAWING C

Model No. 831.25018.0 R0714A

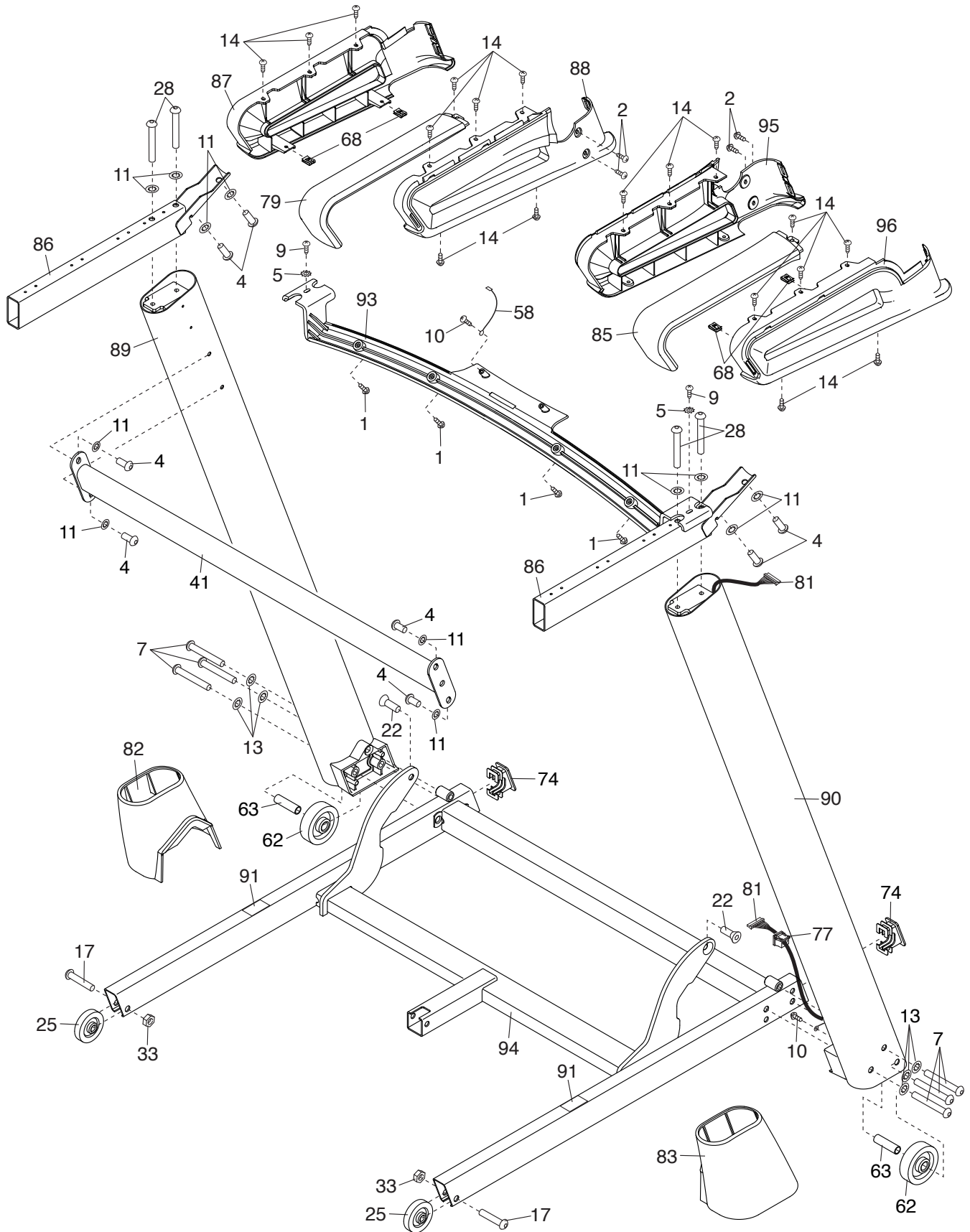

# EXPLODED DRAWING D

Model No. 831.25018.0 R0714A

