

EXPLODED DRAWING A

Model No. 25027.7 R1017A

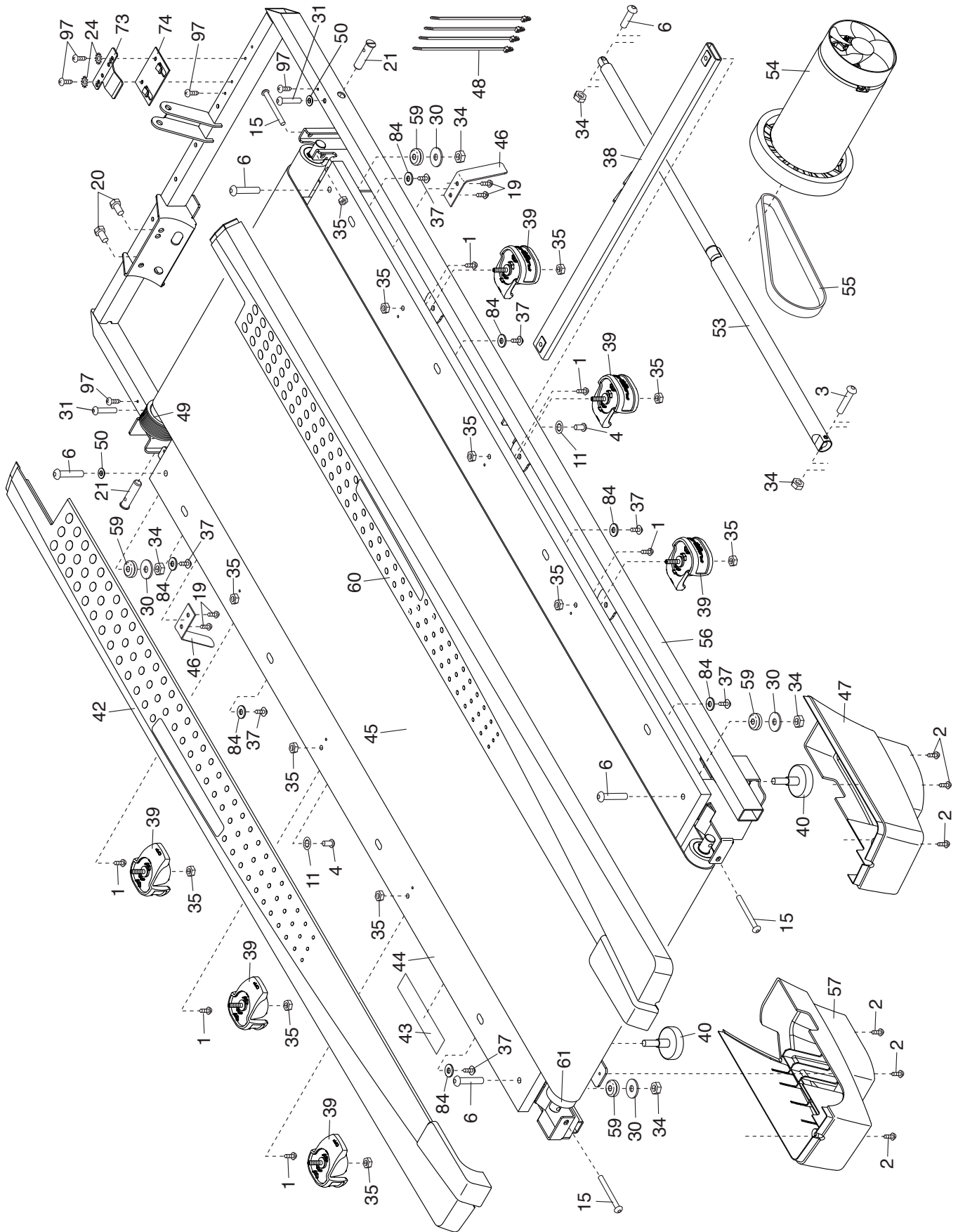

EXPLODED DRAWING B

Model No. 25027.7 R1017A

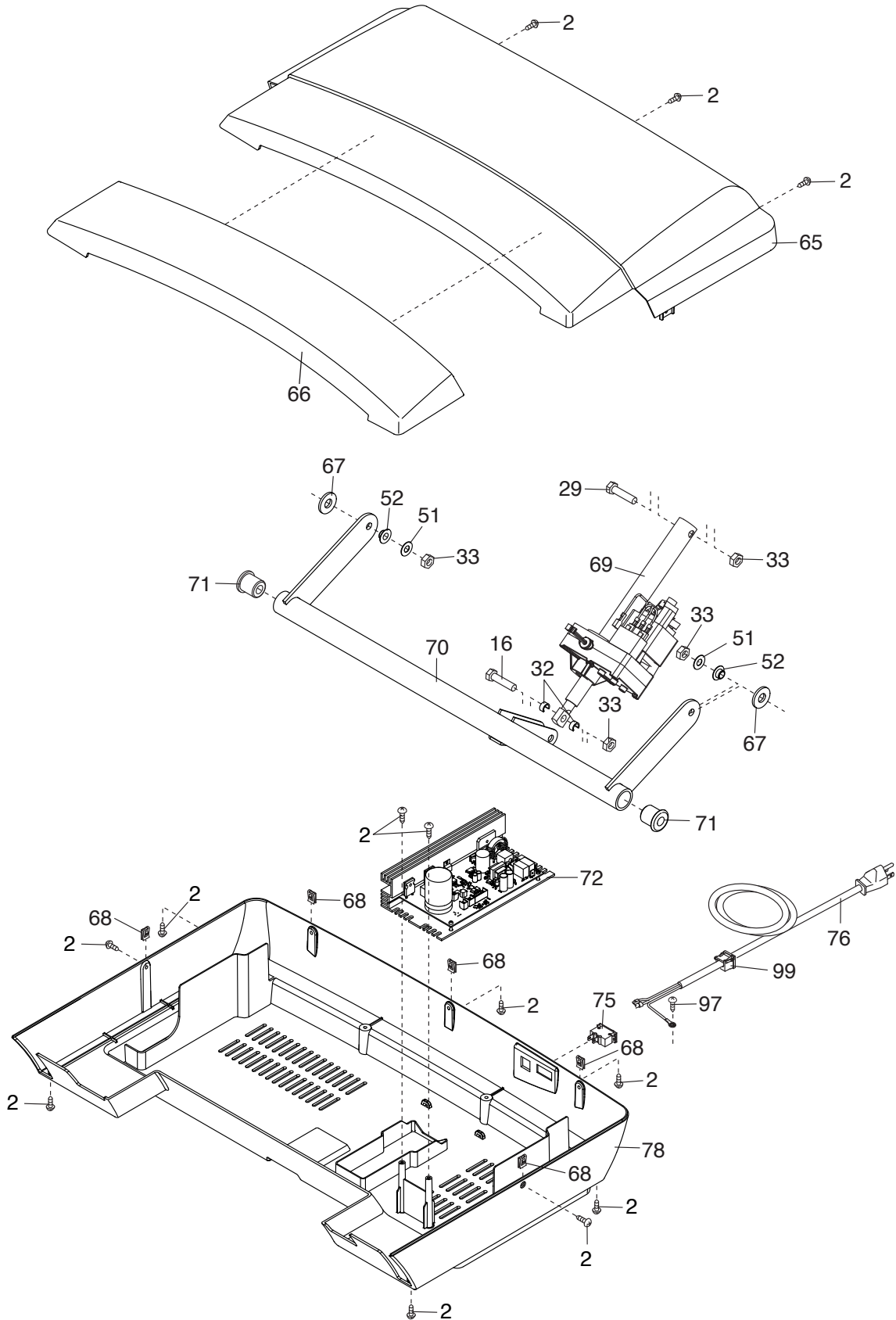

EXPLODED DRAWING C

Model No. 25027.7 R1017A

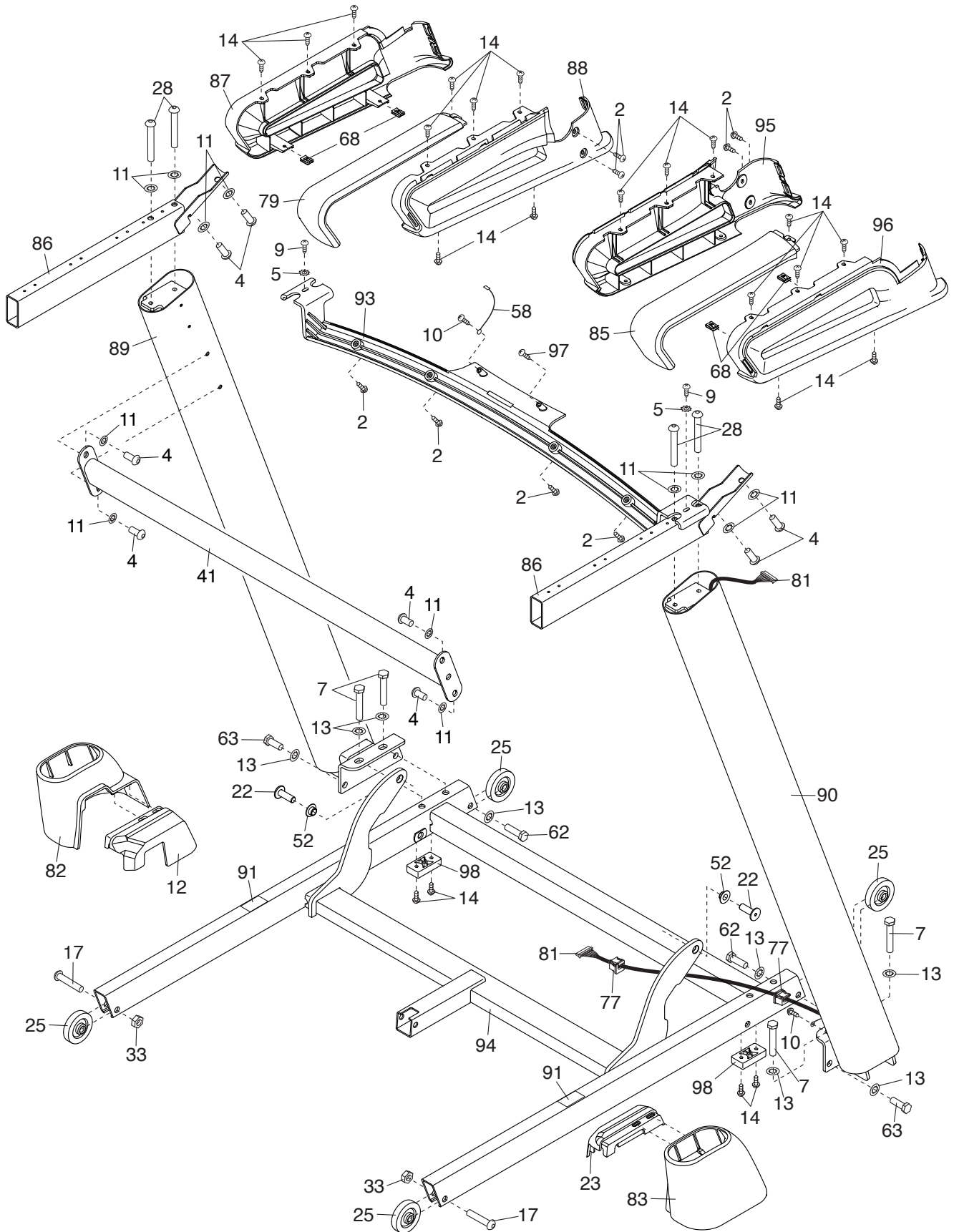

EXPLODED DRAWING D

Model No. 25027.7 R1017A

