

EXPLODED DRAWING A

Model No. 831.25044.0 R0915A

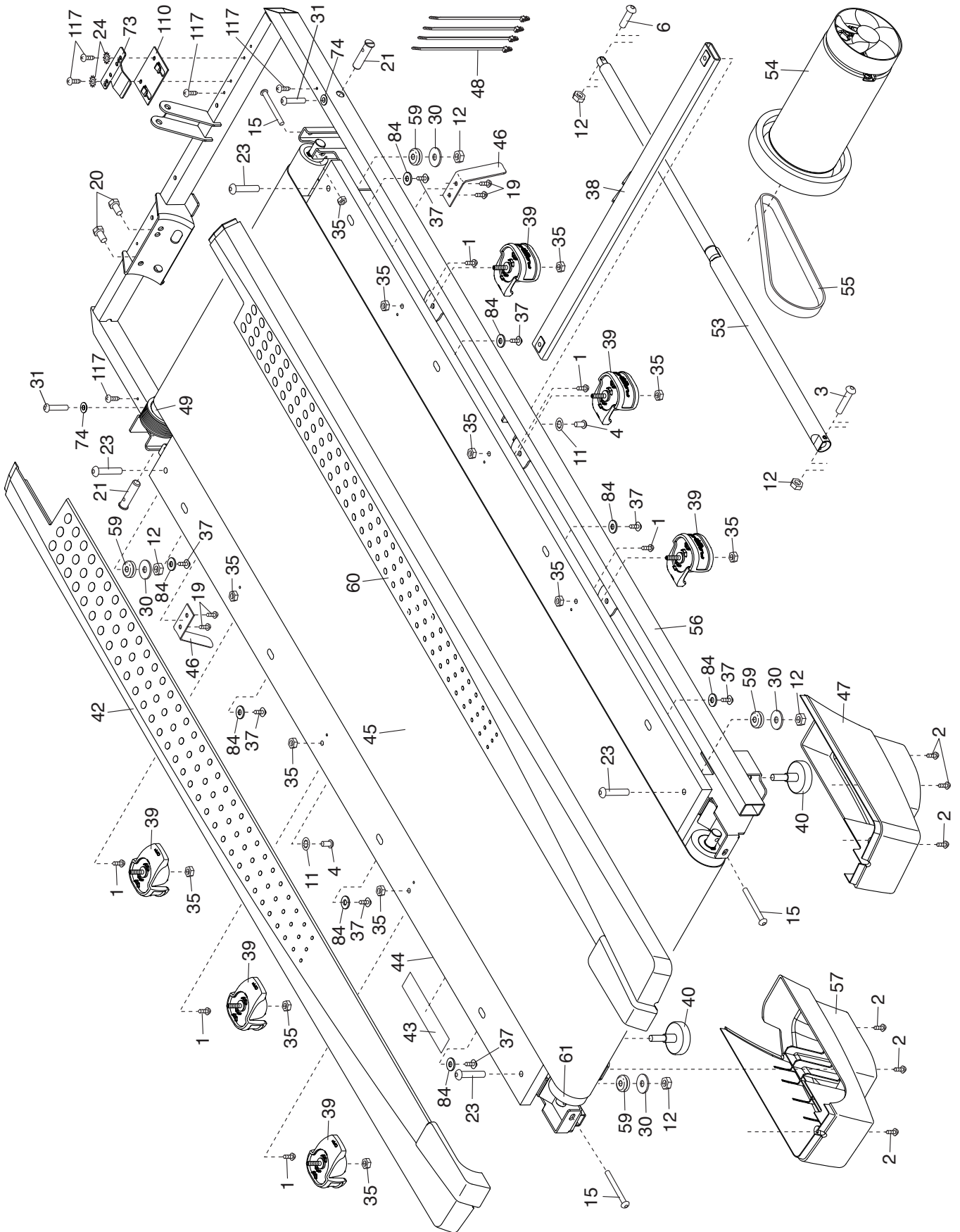

EXPLODED DRAWING B

Model No. 831.25044.0 R0915A

