

EXPLODED DRAWING B

Model No. 831.25049.1 R1015A

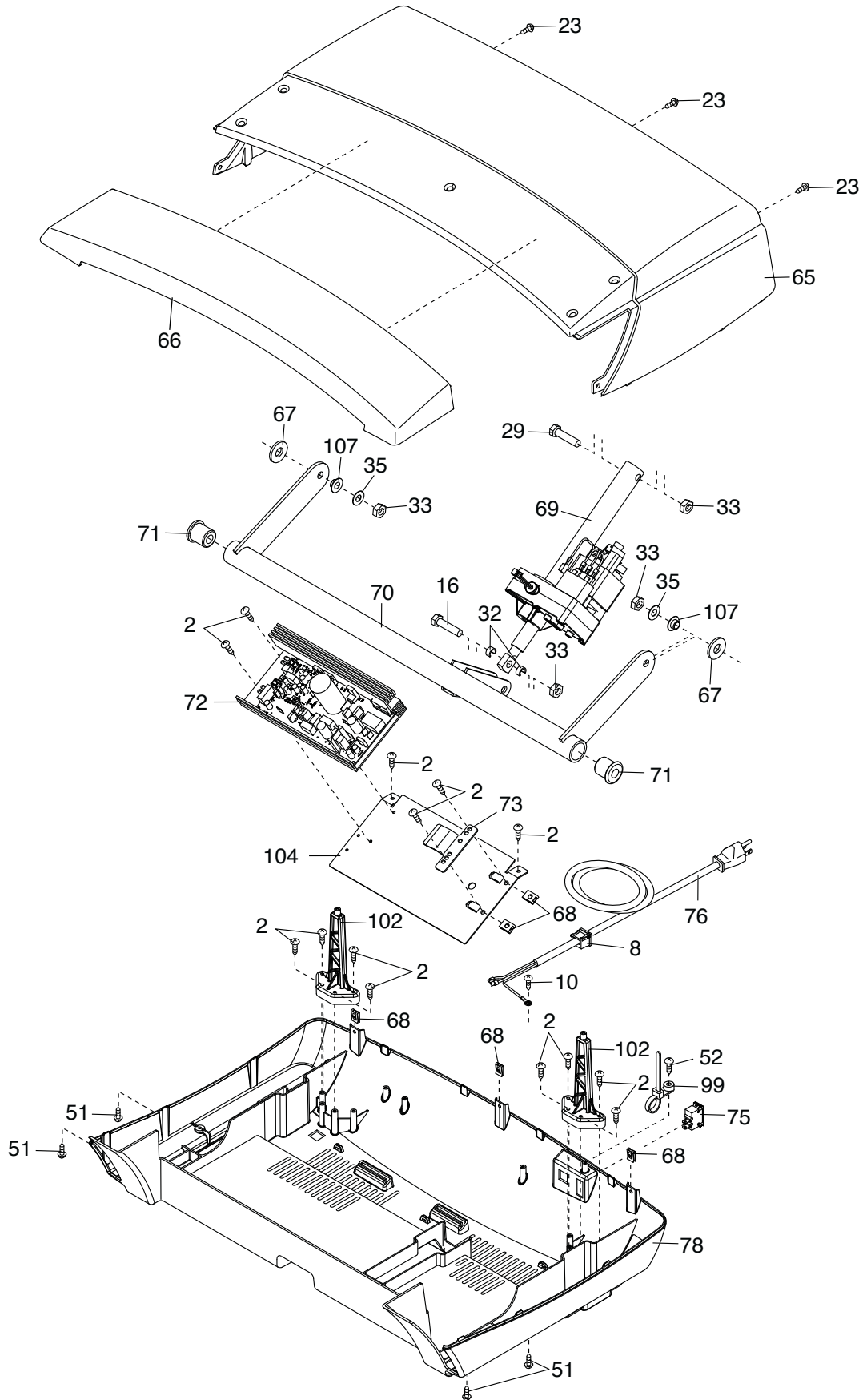

EXPLODED DRAWING C

Model No. 831.25049.1 R1015A

